



OMNIBotics[®] Knee System – ART[™] KNEE Application

INSTRUCTIONS FOR USE

OMNI – 480 Paramount Drive – Raynham, MA 02767



Manufactured by:

OMNIlife science, Inc. (OMNI)

480 Paramount Drive

Raynham, MA 02767

www.OMNIlife.com

For technical support call:

☎ : 800-448-6664

☎ : 508-822-6030

Standards

This product complies with the standards for medical electrical devices

See the instructions for use for each system component listed in §1.3 “Associated documents”.

Copyright

© 2018 OMNI. All rights reserved. Reproduction or transmission of this document (or part of this document) in any format or by any means without written permission from OMNI is not authorized.

Patents

The OMNIBotics® System, OMNI ART™ Knee Application, Instruments, BalanceBot™ and OMNIBot™ are protected by the following patents: US 10,441,437, US 10,321, 904, US 10,383,638, US 10,285,683, US 9,684,768, US 9,421,019, US 9,220,571, US 9,220,510, US 9,050,132, US 9,033,958, US 8,990,052, US 8,880,152, US 8,626,267, US 8,214,016, US 8,126,533, US 8,096,997; US 7,691,108, EP 1 635 715 (FR, GB), DE 602004048029.0, FR 2 856 268, FR 2 852 223, CA 2,954,125, EP 3 273 868 (FR, GB), AU 2016235175. Other patents pending.

Modifications

The information given in this document is subject to modification without notice. We have done our outmost to ensure the accuracy of the information given in this document.

Training options

For safe and effective use of the medical device, the following training courses are recommended:

<i>Name</i>	<i>Reference</i>	<i>Duration</i>	<i>Frequency</i>
OMNIBotics® Knee System – ART™ Knee Application Instructions for Use	IFU-036	2 hours	Surgeon and OMNI personnel to be trained annually. Hospital staff on installation and as needed.
OMNIBotics Station Instructions for Use	IFU-037	2 hours	Surgeon and OMNI personnel to be trained annually. Hospital staff on installation and as needed.

Table 1 - Description and reference codes for training courses

CONTENTS

1	INTRODUCTION.....	8
1.1	PURPOSE OF THE DOCUMENT	8
1.2	CONVENTIONS	8
1.3	ASSOCIATED DOCUMENTS	8
1.4	SPECIAL CONDITIONS FOR USE	9
2	OVERVIEW	10
2.1	INTENDED USE	10
2.2	CONTRAINDICATIONS	11
2.3	MAIN FUNCTIONS	11
2.4	SYSTEM AND ACCESSORIES	12
2.5	OMNIBOT SPECIFICATIONS.....	13
2.6	BALANCEBOT SPECIFICATIONS.....	13
2.7	ELECTROMAGNETIC ENVIRONMENTAL CONDITIONS	14
2.8	ACCURACY	14
2.9	USER INTERFACE.....	15
3	STARTING THE SYSTEM.....	18
3.1	REQUIRED PERSONNEL.....	18
3.2	PREPARATION OF THE SYSTEM	18
3.3	ADDITIONAL SAFETY PRECAUTIONS AND SPECIAL CONDITIONS FOR USE FOR OMNIBOT™	19
3.4	ADDITIONAL SAFETY PRECAUTIONS AND SPECIAL CONDITIONS FOR USE FOR BALANCEBOT	22
3.5	STARTING THE APPLICATION	23
3.6	IMPLANT SELECTION	24
3.7	USER PROFILE SELECTION.....	25
3.8	CASE INFORMATION	26
3.9	POSITIONING THE OMNIBOTICS STATION	28
3.10	STORAGE AND HANDLING	30
4	USING THE SYSTEM	31

4.1	PREPARATION OF NAVIGATION REFERENCES	31
4.2	PREPARATION OF NAVIGATION INSTRUMENTS.....	33
4.3	INSTRUMENTS.....	34
4.4	INSTRUMENT CALIBRATION	36
4.5	REFERENCES AND CAMERA POSITIONING	40
4.6	PATIENT ANATOMY REGISTRATION	48
4.7	OMNIBOTICS BONE MORPHING™ VALIDATION	55
4.8	TIBIAL PLANNING WITH TIBIA OMNIBOTICS BONE MORPHING™.....	58
4.9	FEMORAL PLANNING.....	60
4.10	FEMORAL PLANNING WITH LIGAMENT BALANCING.....	63
4.11	FEMORAL COMPONENT FIT ADJUSTMENT – APEX KNEE ONLY	66
4.12	FEMORAL PLANNING WITH PREDICTIVE BALANCE™	70
4.13	TIBIAL CUT NAVIGATION WITH THE BLADE GUIDE.....	82
4.14	TIBIAL CUT NAVIGATION WITH THE NANOBLOCK™	85
4.15	FEMORAL DISTAL CUT NAVIGATION WITH THE NANOBLOCK™	90
4.16	FEMORAL AP CUT NAVIGATION WITH THE VALIDATION PLATE	94
4.17	FEMORAL CUTS NAVIGATION WITH THE OMNIBOT™	98
4.18	CUT VALIDATION	112
4.19	FINAL BALANCE ASSESSMENT WITH THE BALANCEBOT	118
4.20	LEG ALIGNMENT AND KINEMATICS ACQUISITIONS	128
4.21	KNEE ROTATION MONITORING.....	131
4.22	MODULAR TIBIA IMPLANT – APEX KNEE ONLY.....	133
4.23	RE-CUTTING THE FEMUR AFTER ALL CUTS HAVE BEEN MADE	136
4.24	NAVIGATION REPORT.....	138
4.25	CORINCONNECT CASE ID	139
5	WORKFLOW CUSTOMIZATION AND MENU	141
5.1	DEFINITIONS.....	141
5.2	DEFAULT PROFILES	142
5.3	CUSTOMIZED USER PROFILE SETTING.....	144
5.4	MENU	156
5.5	USING MENU	161
6	TECHNICAL NOTES.....	173

6.1	FEMUR ORIENTATION	173
6.2	TIBIA ORIENTATION	174
6.3	OMNIBOTICS BONE MORPHING™	176
6.4	LEG ALIGNMENT MEASUREMENTS	181
6.5	IMPLANT PLANNING MEASUREMENTS	181
6.6	IMPLANT PLANNING DISPLAY MODES	184
6.7	NAVIGATION STEPS	185
7	TROUBLESHOOTING	186
8	MAINTENANCE AND MONITORING.....	190
8.1	MAINTENANCE OF THE OMNIBOT:	190
8.2	MAINTENANCE OF THE BALANCEBOT:	190

1 Introduction



1.1 Purpose of the document

This document provides a set of instructions for use of the **OMNIBotics Knee System** including use of the OMNI ART™ Knee Application, use of the OMNIBot™ and use of the BalanceBot™ and associated instruments.

It facilitates set-up of the OMNIBotics Knee System and its routine use with OMNI ART, OMNIBot and BalanceBot and the initial troubleshooting and maintenance phases.

This document is intended for any surgeon user, sales representative or hospital staff member that will be assisting a surgical procedure or providing supervision of the OMNIBotics Knee System. These personnel should also be trained on the OMNIBotics Station instructions and complete any additional training requirements set by OMNI.

1.2 Conventions





	WARNING: This symbol precedes any hazard involving the health and/or safety of users and patients.
	RECOMMENDATION: This symbol precedes any advice on the use of the system, which has no incidence on the health and/or safety of users and patients.

1.3 Associated documents

- Instructions for Use “OMNIBotics Station” (IFU-037)
- Instructions for Use “OMNIBotics Tracker Kit” (IFU-035)
- Instructions for Use “OMNIBotics Knee System and OMNIBot Instruments” (IFU-039)
- Instruction for Use “BalanceBot™ Instruments” (IFU-040)

1.4 Special conditions for use







The **OMNIBotics Knee System** should not be used without first having read the material listed in §1.3 “Associated documents” and understanding their content.

	RECOMMENDATION: Read and understand the entire Instructions for Use and the Associated Documents before using the OMNIBotics Knee System with the ART Knee Application, OMNIBot™ and BalanceBot™.
	RECOMMENDATION: Access to the computer systems contained in the OMNIBotics Station is strictly reserved for personnel authorized by the manufacturer, OMNI.
	RECOMMENDATION: The usage quantity for each OMNIBot enclosure must be recorded to ensure proper maintenance.
	RECOMMENDATION: The usage quantity for each BalanceBot must be recorded to ensure proper maintenance.

2 Overview

2.1 Intended Use

The OMNIBotics® Knee System is indicated for stereotaxic surgery to aid the surgeon in locating anatomical structures and aligning endoprotheses with these anatomical structures during Total Knee Arthroplasty. The BalanceBot™ is indicated as a tool for adjustment of soft tissue and the femoral implant to reduce instability from flexion gap asymmetry. The OMNIBotics® Knee System supports OMNI Apex Knee™ implants and CORIN Unity Knee™ implants.

	WARNING: In the event that the OMNI ART fails and the surgeon must revert to conventional surgical protocol, make sure that a sterile set of conventional instruments (Apex Knee or Unity Knee) is available before starting any procedure with the system.
	WARNING: System must be used with a maintained OMNIBot™ Motor Unit and a maintained BalanceBot.
	WARNING: In the event that the use of a defibrillator is required, unplug the OMNIBot Cable and the BalanceBot Cable.
	WARNING: To avoid performance or safety issues, any modification to the OMNIBot system or to the BalanceBot system is prohibited.
	WARNING: The OMNIBot and the BalanceBot can only be connected to OMNIBotics Station and can only be used in conjunction with the indicated instruments. Any use not supported by OMNI can damage these systems.
	WARNING: A trained and authorized operator familiar with the conditions for using the Emergency Stop Button on the OMNIBotics Station must be present and able to shut down the OMNIBot system and/or the BalanceBot system in case of an emergency.

Caution: Federal (USA) Law restricts this device to sale by or on the order of a physician.

2.2 Contraindications

Absolute contraindications include:

- Use with implants or procedures other than Total Knee Replacement with the Apex Knee or the Unity Knee.
- Use by a doctor who has not been duly trained in the OMNIBotics® technique
- Any contraindications outlined for the Apex Knee or the Unity Knee.

Relative contraindications include:

- Any contraindications outlined for the Apex Knee or the Unity Knee.

2.3 Main functions

The main functions of the ART™ Knee Application are the following:

- **3D virtual planning:** Based on proprietary OMNIBotics Bone Morphing™ Technology the user can virtually plan tibial and femoral implant position. The OMNI ART helps the user obtain a position that is judged to be optimal by using predefined anatomic and kinematic criteria (for more details, see §0 and §4.9).
- **Tibial and Femoral cut navigation:** The system controls the exact position of the planned cuts as well as position of the cutting guides. Cutting guides can be either standard cutting guides (Apex Knee or Unity Knee) that can be equipped with a tracker or specific OMNIBotics guides (for more details, see §4.12 to 4.17).
- **Leg alignment and balance control:** During the computer assisted protocol, the user can control leg alignment, stability and mobility in real time (for more details, see §4.10).

2.4 System and Accessories

The ART Knee Application is part of the OMNIBotics Knee System and must be used with the following system accessories:

- An OMNIBotics Station

PRODUCT CODE	QTY	DESCRIPTION	ILLUSTRATION
NV-F2200	1	OMNIBotics Station Full Station; US Station; NON-UPS; Wired Footswitch	

- A modular navigation software: OMNI ART Knee Software

PRODUCT CODE	QTY	DESCRIPTION	ILLUSTRATION
NS-27114	1	ART Knee Software v2.7	

- One of the OMNIBotics Knee set of instruments with its sterilization pan and trays (Apex Knee or Unity Knee):

PRODUCT CODE	QTY	DESCRIPTION	ILLUSTRATION
KK-S1001	1	OMNIBotics Knee Instrument Kit – Navigation for Apex Knee	
KK-S1002	1	OMNIBotics Knee Instrument Kit – OMNIBot for Apex Knee	

Or

PRODUCT CODE	QTY	DESCRIPTION	ILLUSTRATION
KK-S6000	1	Robotics Cables Sterilization Case	
KK-S6001	1	Robotics Instruments OMNIBotics Total Knee – Apex Knee	

Or

PRODUCT CODE	QTY	DESCRIPTION	ILLUSTRATION
KK-S6000	1	Robotics Cables Sterilization Case	
KK-S6003	1	Robotics Instruments OMNIBotics Total Knee – Unity Knee	

- A motor unit (non-sterile) - OMNIBot option

PRODUCT CODE	QTY	DESCRIPTION	ILLUSTRATION
4144-6000	1	OMNIBot Motor Unit	

- Disposable OMNI reflective markers

PRODUCT CODE	QTY	DESCRIPTION	ILLUSTRATION
RM-1000X Series	1	OMNIBotics Tracker Kits including: - 20 Single Use Sterile Markers - 1 USB Drive	

2.5 OMNIBot Specifications

OMNIBot Cutting Guide Assembly	
Dimensions	3.9 x 2.6 x 6.4 in (width x depth x height)
Weight	1.6 lbs
Interface types	Motor Unit: Fisher connection
Motor Unit – Enclosure Box connection cable length	255 in
Ingress Protection for the enclosure	IP 45
Ingress Protection for the motor unit	IP 30

2.6 BalanceBot Specifications

BalanceBot Motor Unit	
Dimensions	2.8 x 2.5 x 6.7 in (width x depth x height)
Weight	1.230Kg (2.7 lbs)
Interface types	Fisher connection
Motor Unit – Enclosure Box connection cable length	6.0m (19ft 8in)
Ingress Protection for the unit	IP X7

2.7 Electromagnetic Environmental Conditions

For detailed guidance regarding OMNIBotics Station, OMNIBot and BalanceBot electromagnetic environmental conditions, please refer to OMNIBotics Station Instruction for Use listed in §1.3 « Associated documents ».

2.8 Accuracy

The global accuracy of the OMNIBotics® Knee System with ART Knee Application is $\pm 1\text{mm}$ and $\pm 1^\circ$ in normal condition of use.



The accuracy of the system has been verified in multiple experiments and includes repeated measurements from multiple users on a standard phantom subject.

2.9 User Interface

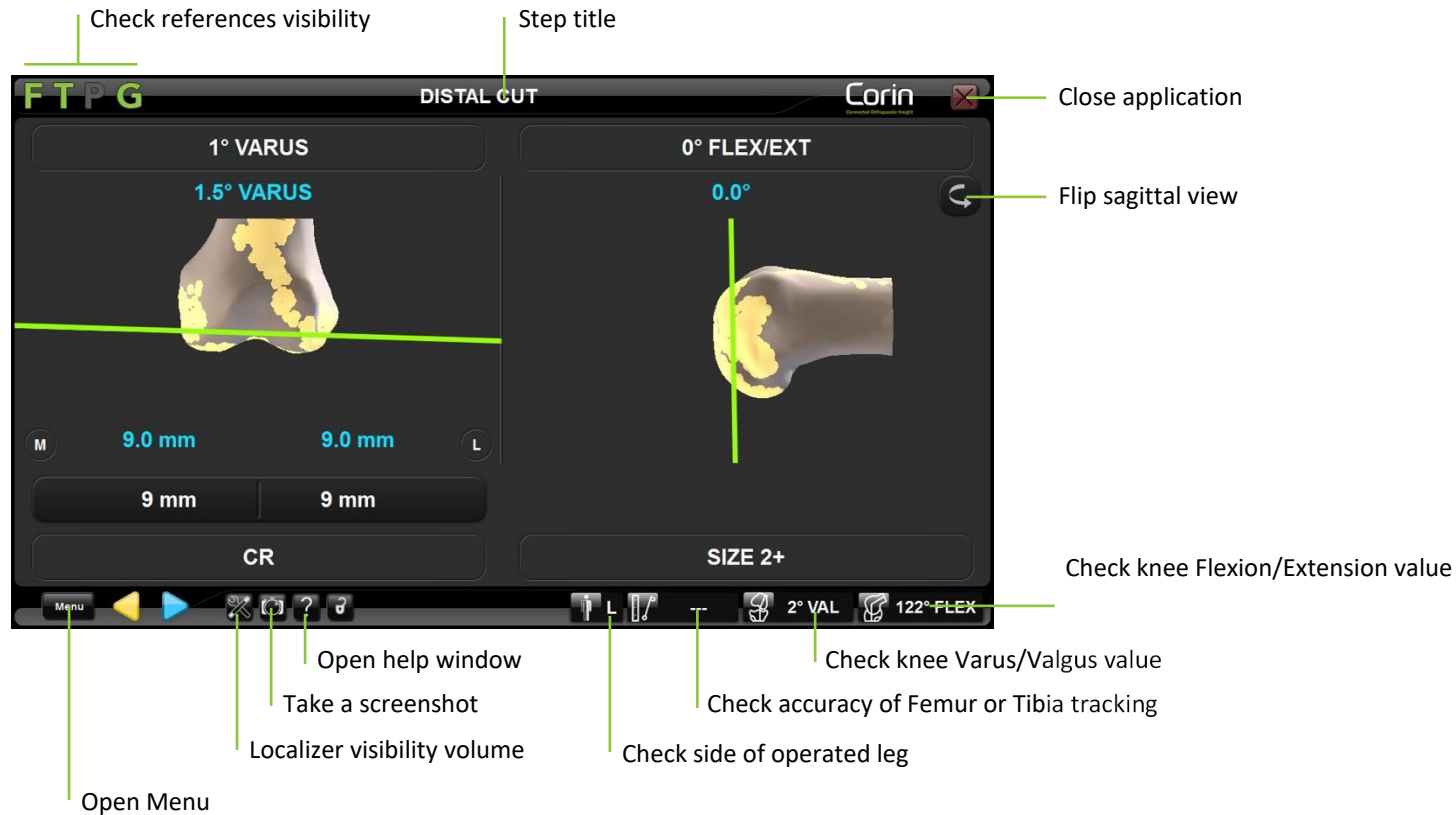

During the protocol, the system is controlled via the ART Knee Application graphical user interface. This interface has been designed and optimized for use on touch screens of the OMNIBotics Station.



Going forward and backward in the workflow:

- Touch  to start an acquisition or to validate a step.
- Touch  to go back to a previous step.

Note: When going back to a previous step, only specified step where you stop has to be redone.

The OMNIBotics® Station is equipped with a three-switch foot pedal. The use of the blue pedal is equivalent to . The use of the yellow pedal is equivalent to .

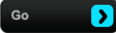



Reviewing or moving to another step in the workflow: Touch  to open the Menu and select the step to review. Double click the corresponding item or touch  to go to the selected step (for more details see §5.4).

The use of the black switch on the foot pedal is equivalent to  / .

Checking reference visibility:

All OMNIBotics Knee Instrument sets include a set of four navigation references that are equipped with disposable reflective markers. These references are F for Femur, T for Tibia, P for Pointer and G for Guide. The ART Knee Software indicates which references are required during the computer assisted protocol through a color scheme: green = guide is visible to system, red = guide is not visible to system and required for current step, and gray = guide is not visible and not required to complete current step.

Examples:

-  (a green F) indicates that the Femur reference is visible to the tracking system.
-  (a green T) indicates that the Tibia reference is visible to the tracking system.
-  (a red P) indicates that the Pointer reference is required to complete the current step but it is not visible to the tracking system.
-  (a gray G) indicates that the Guide reference is not visible to the tracking system and is not required to complete the current step.

Note: “INFRARED DETECTED” in the upper part of the screen indicates that the system cannot detect the references due to infrared interference.

Checking the localizer visibility volume: Touch  to display the References and Camera screen. This will show the location of the references in the localizer visibility volume.



RECOMMENDATION: Make sure that only one set of references (F, T, P, and G) is in the camera field.



Taking a screenshot: The current screen will be saved to the report.

Note: Screenshots can be exported to external media (USB drive or CD-R) at the end of the computer assisted procedure.



Help screen: Displays the Help window and provides detailed information about actions required to complete the current step.



Operated knee indicator: The operated knee is indicated by a letter (L for left, R is for right).



Varus/valgus angle: Displays the current HKA varus / valgus angle.

Note: The T and F references must both be visible and is only available after the mechanical axis acquisitions have been completed.



Flexion angle: Displays the current HKA flexion angle.

Note: The T and F references must both be visible and is only available after the mechanical axis acquisitions have been completed.



Accuracy of femur/tibia reference position: Place the P reference in contact with the femur or the tibia in an area where the OMNIBotics Bone Morphing™ acquisition has been performed. If single point acquisition has been used on the tibia, place the pointer on the confidence point. The distance between the pointer tip and the virtual model of the femur/tibia is shown. The distance should remain 0-1.0mm during the entire procedure to ensure the references are properly secured and fixed to the bone.

Note: The P reference and either T or F reference must both be visible and is only available after the OMNIBotics Bone Morphing™ acquisitions has been completed.



Flip sagittal view: The sagittal view will toggle from Lateral side view to Medial side view.



Close the application: Closes the navigation software and will prompt to save the navigation report.

3 Starting the system

3.1 Required personnel

No additional staff is required for the operation of the system other than those required for conventional total knee arthroplasty.

3.2 Preparation of the system

OMNIBotics Knee Instrument sets

All OMNIBotics Knee instruments as well as manual knee instruments (Apex Knee or Unity Knee) must be sterilized prior to use.

The OMNIBotics Knee instrument set including the OMNIBot Enclosure should be cleaned and sterilized as outlined in additional provided documents IFU-039 (OMNIBotics Knee System and OMNIBot Instruments).

The BalanceBot and its instrument set should be cleaned and sterilized as outlined in IFU-040 (BalanceBot Instruments).

OMNIBot & BalanceBot motor units

The OMNIBot and the BalanceBot motor units should be visually inspected for any signs of deterioration prior to conducting a surgical procedure. Physical signs of deterioration include pitting or corrosion of the metallic components and cracking, crazing, swelling, or excessive softening or brittleness of the polymeric external pieces.

If the OMNIBot or the BalanceBot motor unit is dropped, bumped, or subjected to impact, a visual inspection must be performed. If there is a doubt on the integrity, the unit must be sent back to OMNI.

Any instruments that have physically or functionally deteriorated should be removed from service. The cleaning process may cause discoloration of the metallic components but should not affect the function of the instrument.

OMNI accepts no responsibility in the event of incorrect use of the system, instruments and accessories.

Sterility / Handling:

The OMNIBot Motor Unit is delivered non-sterile.

Decontaminate the Motor Unit before and after any installation or use in the operating room. The purpose of decontamination is to reduce the population of micro-organisms.

During the decontamination phase, the conditions of use of the decontaminants must be strictly observed. Adequate personal protection measures must be taken.

The BalanceBot is delivered non-sterile.

The BalanceBot Motor Unit as well as the instrument set, must be cleaned and sterilized prior to use.



Decontaminating the OMNIBot Motor Unit





Wipe the Motor Unit with a clean cloth moistened with a neutral enzymatic detergent that is safe to use on anodized aluminum. Refer to detergent manufacturer's instructions for use to ensure that the product is compatible.

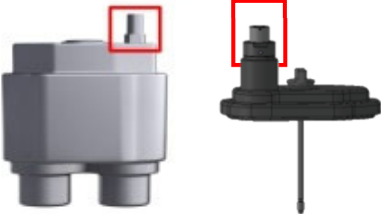

Markers

A box of 20 OMNI Reflective markers is required for each use of the system. It is provided with each OMNIBotics Tracker or Disposable Kit (RM-10000, RM-10001 RM-10002, RM-10003, RM-10004 or RM-10005). It contains 20 single use sterile reflective markers dedicated to navigation with the OMNIBotics® System and OMNI ART Knee Application. A minimum of 18 markers are required when using the 3 markers arrays (0501-XXXX Series) leaving 2 additional markers in case one or more markers are damaged during surgery and require replacement (falls, blood, etc.). All 20 markers are required when using the 4 markers arrays (NS-300X4 Series) leaving no additional marker.





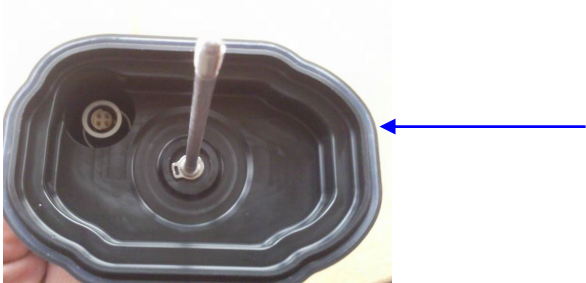

3.3 Additional Safety Precautions and Special Conditions for Use for OMNIBot™

	WARNING: Never immerse or sterilize the OMNIBot Motor Unit. It was not designed for such use. It will be irreversibly damaged if immersed and/or sterilized.
	WARNING: The OMNIBot Sterile Enclosure (main body and cover) provides a microbial barrier that has been proven effective in laboratory testing. However, to minimize contamination risk, OMNI recommends maintaining the Motor Unit in a clean and decontaminated condition.
	WARNING: The OMNIBot is a highly precise instrument and should be handled with care.

	<p>WARNING: Never Open:</p> <ul style="list-style-type: none"> - The OMNIBot Motor Unit connector - The OMNIBot Sterile Cover connector <div style="text-align: center;">  </div>
	<p>WARNING: NEVER OPEN OR DISASSEMBLE THE OMNIBot MOTOR UNIT. The OMNIBot Motor Unit was not designed to be opened by the user. Only a trained OMNI technician should open the unit. In case of a problem, contact technical support.</p>
	<p>WARNING: Do not use the OMNIBot if a part of the OMNIBot Motor Unit is deteriorated or damaged.</p>
	<p>WARNING: The Cable is equipped with a push-pull connector. To unlock it, gently pull on connector outer sliding sleeve to release it. DO NOT APPLY ROTATION TO THE CONNECTOR. DO NOT PULL ON THE CABLE ITSELF.</p>

	<p>RECOMMENDATION: Visually inspect and verify the presence and integrity of the seal of the OMNIBot cover before each use.</p> 
	<p>RECOMMENDATION: Decontaminate the Motor Unit immediately after each surgery.</p>
	<p>RECOMMENDATION: The number of sterilization cycles for the OMNIBot enclosure must be recorded and maintained so that the enclosure can be replaced once the limit has been reached.</p>

3.4 Additional Safety Precautions and Special Conditions for Use for BalanceBot

	<p>WARNING: The BalanceBot is a highly precise instrument and should be handled with care.</p>
	<p>WARNING: NEVER OPEN OR DISASSEMBLE THE BALANCEBOT UNIT. The BalanceBot Unit is a sealed assembly and was not designed to be opened by the user. Only a trained OMNI technician should open the unit. In case of a problem, contact technical support.</p>
	<p>WARNING: Do not use the BalanceBot if deteriorated or damaged.</p>
	<p>WARNING: The Cable is equipped with a push-pull connector. To unlock it, gently pull on the connectors outer sliding sleeve to release it. DO NOT PULL ON THE CABLE ITSELF.</p>
	<p>WARNING: Never disconnect the BalanceBot cable when the BalanceBot is engaged in Force or Height mode as it could damage some electronic component of the BalanceBot.</p>
	<p>RECOMMENDATION: Although usage of the BalanceBot is monitored by ART Knee Software, the number of sterilization cycles that the BalanceBot undergoes should be recorded and tracked so that required maintenance can be planned in advance of reaching the limit.</p>

3.5 Starting the application

Launching the ART Knee Software: Turn on the OMNIBOTICS® Station and touch the ART Knee Software icon on the screen (for more details refer to the OMNIBOTICS Station – Instructions for use). Once the application has started it displays the following “Welcome” screen:



Touch  to go to “Implant Selection”.

3.6 Implant selection

Select the implant: Touch the button corresponding to the implant to be used for the surgery. Touch  to go to “User Profile Selection”.

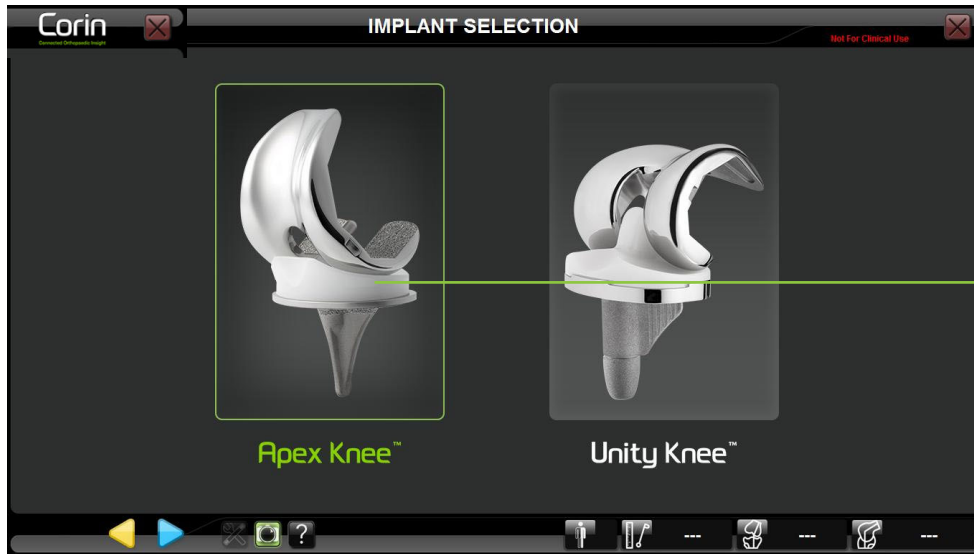

Select the implant to be used for the surgery

Note: The system requires a confirmation of the implant selection. Touch CONFIRM to confirm the implant selection or touch BACK to modify the selection. After this step it will not be possible to change the implant selection without having to restart the ART Knee software.



WARNING: Make sure that the implant selected is the correct one or the implant planning will not be matching the available implant.

3.7 User profile selection

Select the profile: Touch the name of the profile in the user profile list and verify that the illustrated instruments are the desired instruments for use. If no modification is required to the selected profile, then touch  to go to “Patient Information”.

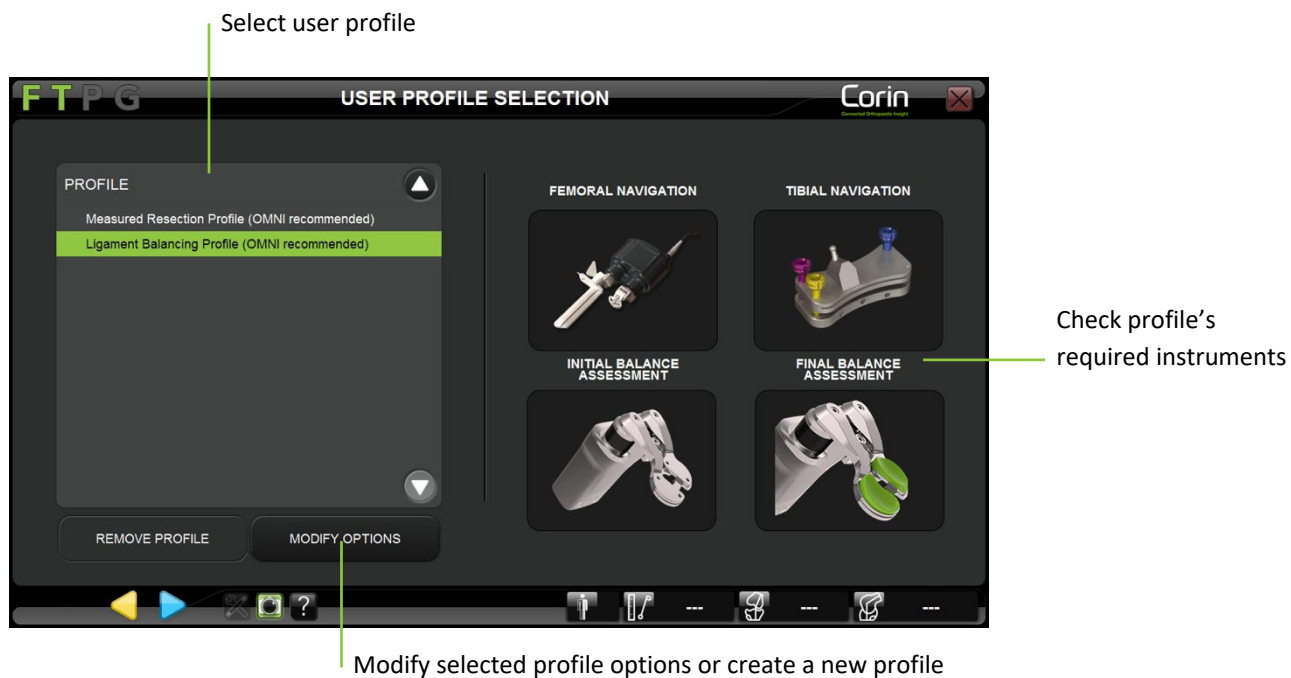

Note: OMNI ART™ Knee Software is preinstalled on every Station with default profiles recommended for Apex Knee or Unity Knee. For additional information about predefined profiles refer to §5.2

Creating/modifying a profile: Touch the profile to modify and touch MODIFY OPTIONS (for more details see §5.3).

3.8 Case information

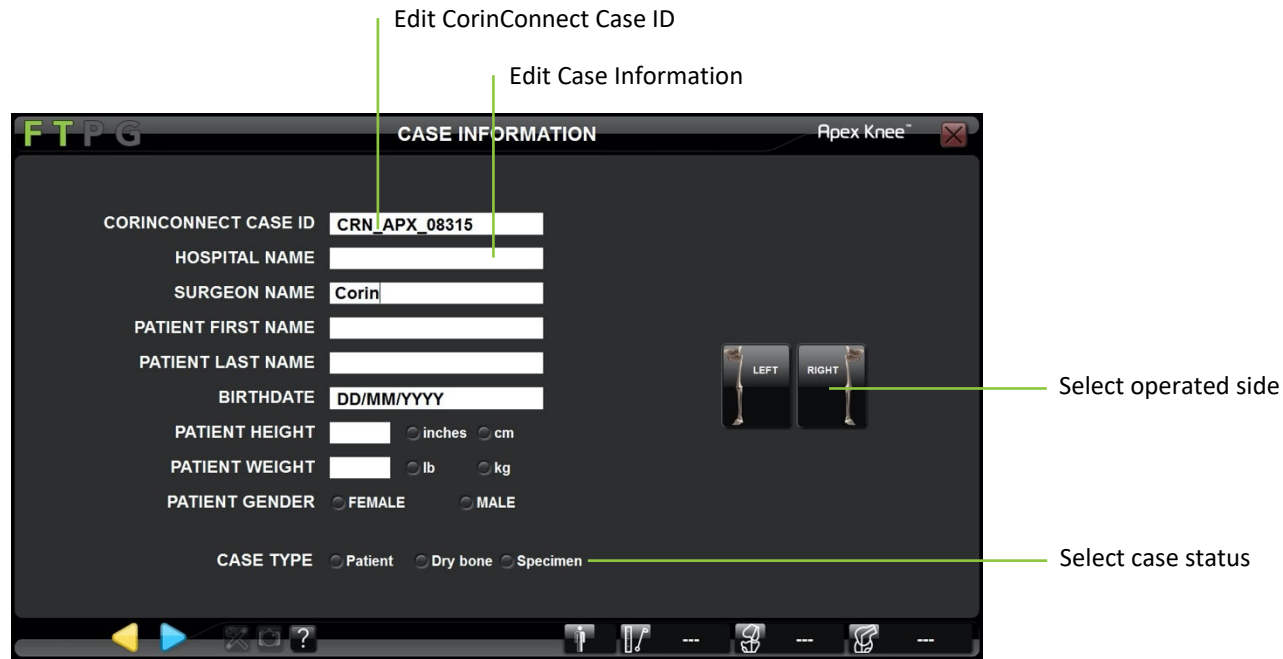



Editing case information: Touch any text input field and use the laptop keyboard to enter the information.

Selecting operated knee side: Touch the Right or Left button.

Select case status: Touch Patient, Specimen or Dry Bone radio button.

Entering CorinConnect Case ID:

- Touch the CorinConnect Case ID input field.
- Enter the CorinConnect Case ID created during the booking of the case on CorinConnect.
- The CorinConnect Case ID provided is used as the primary key to link OMNIBotics case data with patient data and surgeon profile on CorinConnect.

	<p>RECOMMENDATION: The booking of your OMNIBotics cases should occur before the beginning of the surgery (See §4.25) as the CorinConnect Case ID is required here by the OMNIBotics Knee System.</p>
	<p>RECOMMENDATION: The CorinConnect Case ID should be recorded carefully for each patient so it can be accurately entered onto the OMNIBotics Knee System. The CorinConnect Case ID should always respect the following format: ABC-DE-12345 or ABC-DEF-12345</p>
	<p>RECOMMENDATION: In case the CorinConnect case ID is not recognized by the OMNIBotics Knee System or if it cannot be retrieved before the start of the surgery, it is possible to use the following back-up ID:</p> <p style="text-align: center;">EMG-CID-11937</p> <p>In such case, we recommend you save the case data immediately at the end of the case on the USB key provided with the OMNIBotics Tracker Kit. An OMNIBotics case ID can be retrieved on the PDF report generated on the USB key that will allow you to link a late booking (after surgery) with corresponding OMNIBotics data on CorinConnect.</p> <p>In the absence of case booking on CorinConnect the surgeon won't be able to retrieve OMNIBotics case data on CorinConnect.</p>

- Touch  to go to "Pointer Calibration".

Note: The operated side and the case status must be selected before proceeding to the next step. Choosing the "Patient" status will increment the number of usage of the BalanceBot and make the CorinConnect Case ID mandatory.

Note: The CorinConnect Case ID will be displayed in the upper right corner of the screen below the selected implant system's name as illustrated below:



3.9 Positioning the OMNIBotics Station

Standard set-up: In the operating room the system can be positioned on either side of the operated knee outside the patient environment. It is recommended that the system be set up on the opposite side of the patient from the surgeon.

The camera should be placed approximately 5 to 6 feet (1.5 to 1.8 meters) from the knee.

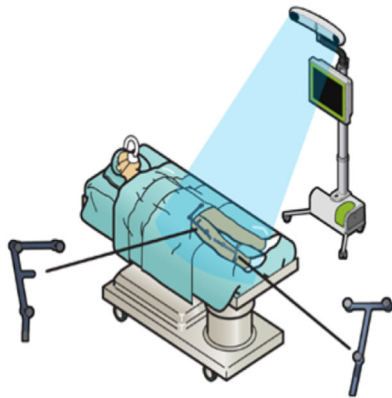

Set-up for a right knee

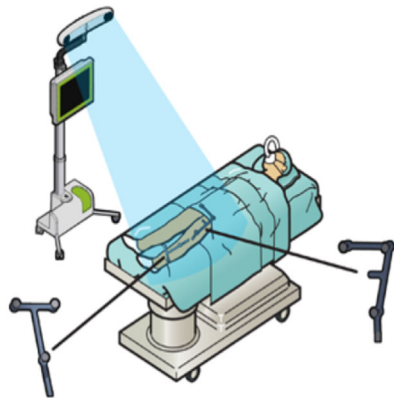

Set-up for a left knee

When using the OMNIBot™ or the BalanceBot, the motorized device and its associated instrumentation should be located inside the patient area.

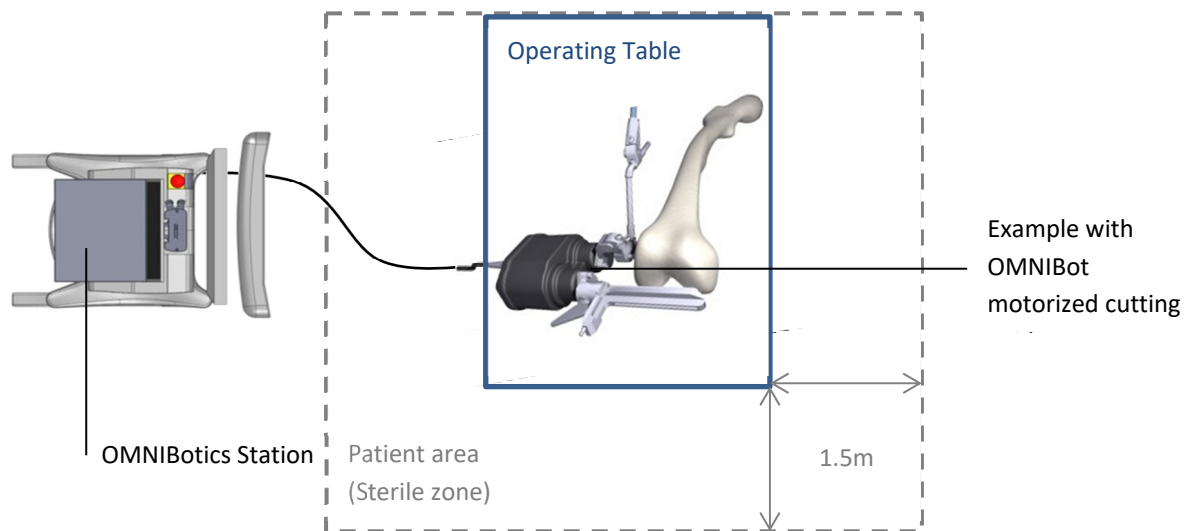





RECOMMENDATION: All electrical medical equipment in the Patient Area (sterile zone) must be connected together with a potential equalization cable

3.10 Storage and handling

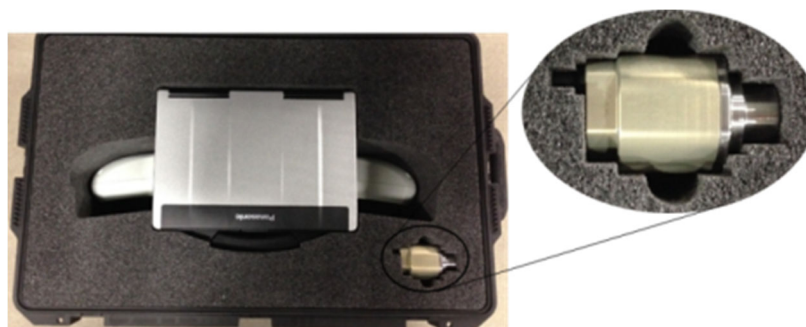
See the instructions for use of the system components listed in §1.3 « Associated documents ».

Note: OMNIBot Motor Unit can be stored in the OMNIBotics Station drawer and it can be shipped with the OMNIBotics system using the shipping case for camera, laptop, and motor unit:



	WARNING: Instruments must be decontaminated and sterilized by autoclave after each use.
	WARNING: Loosen all screws before cleaning, decontaminating and sterilizing the instruments.
	WARNING: The “Femur Bone Fixation Base” clamps onto the “Cancellous Bone Screws” with a permanently captured 3.5mm hex locking screw that cannot be removed from the base. When mounting and dismounting the “Femur Bone Fixation Base” with the “H3.5 Screwdriver”, care should be taken not to apply excessive torque to over-tighten or over-loosen the locking screw as this could damage the screw.

4 Using the system

4.1 Preparation of navigation references

Unpack the 20 OMNI Markers (#1301-1020 or NS-26220) from the OMNIBotics Tracker or Disposable Kit (RM-10000, RM-10001 RM-10002, RM-10003, RM-10004 or RM-10005) and snap a marker on each post of the navigation references.

Note: The reflective part of the marker is fragile and sensitive to soiling. They should be handled with care and avoid touching the reflective surface with dirty gloves.

4.1.1 Using a set of 3 markers arrays



- 3 markers onto Tibia - “T” reference (#0501-5030)
- 3 markers onto Femur - “F” reference (#0501-5020)
- 6 markers onto Pointer - “P” reference (#0501-5000)
- 6 markers onto standard Guide – “G” reference (#0501-5070)
or 8 markers onto optional Guide “G” reference (#NS-3000G)

4.1.2 Using a set of 4 markers arrays



- 4 markers onto Tibia - “T” reference (#NS-300T4)
- 4 markers onto Femur - “F” reference (#NS-300F4)
- 4 markers onto Pointer - “P” reference (#NS-300P4)
- 8 markers onto Guide - “G” reference (#NS-300G4)



WARNING: The markers must be securely attached to the posts of the references. Correct fixation is characterized by a "click".



WARNING: The markers are disposable and single use.

4.2 Preparation of navigation instruments

Verify instruments and screws: Before each use of the system, verify that there is no mechanical play in assemblies or abnormal deformations of instruments and screws. Check all reproducible interfaces. Do not use the system or replace parts if any faults are observed.

Verify the OMNIBot™ & the BalanceBot: Before using the OMNIBot and/or the BalanceBot on a patient, a thorough visual inspection must be performed to detect any abnormal wear or failure in the seals of the device.

For the OMNIBot, ensure that:

- the two OMNIBot axes are free to turn with no noticeable play or backlash;
- all of the joints and seals are completely dry;
- the seal that is on the edge of the OMNIBot Cover (#4144-4000 or NS-42000) is present and in good condition.

For the BalanceBot, ensure that:

- the two BalanceBot axes are free to move up and down with no noticeable play or backlash;
- the bellows are not significantly dented.







Do not use the active device if there is a failure in any of its features.

See the instructions for use of the system components listed in §1.3 « Associated documents ».

4.3 Instruments

The system provides the NanoBlock™ and the OMNIBot as dedicated cutting guides for Tibia and Femur preparation. It is also compatible with the tibial cutting guide, femoral distal cutting guide, and femur 4-in-1 cutting guides of the conventional instrumentation set for Apex Knee or Unity Knee.

The following instruments require calibration with the system:

PRODUCT CODE	DESCRIPTION	SUPPLIER	ILLUSTRATION	COMPATIBILITY
4160-5000	Blade Guide With Reattachable Fixation Interface	OMNI		Tibial Cut with Tibial Cutting Block (#WS-20002 & WS-20003)
4137-5000	NanoBlock	OMNI		Tibial Cut Femoral Distal Cut
4161-5400 or NS-40500	Apex Knee Validation Plate	OMNI		Apex Knee Femoral AP Cuts with 4 in 1 Femoral Cutting Blocks Cut validation
NS-54035	Apex Knee and Unity Knee Validation Plate	OMNI		Apex Knee and Unity Knee Femoral AP Cuts with 4 in1 Femoral Cutting Blocks Cut validation
4146-5200 or XK-06471	OMNIBot™ Saw Guide 1.27mm - Short	OMNI		Femoral Cuts (all) with OMNIBot
4146-5300 or XK-06449	OMNIBot Saw Guide 1.27mm	OMNI		Femoral Cuts (all) with OMNIBot

Attaching the G reference to the navigation instruments:

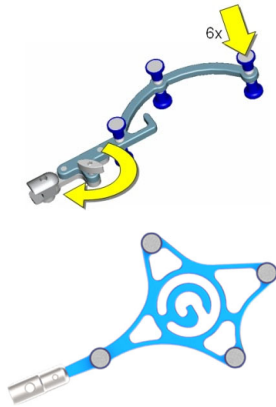

- If using the standard (#0501-5070) or the optional (#NS-3000G) “G” reference, then use the Reattachable Fixation For “G” (#4146-5000) illustrated bellow. Assemble the “G” reference (#0501-5070 or NS-3000G) by aligning the three (3) holes on the Reattachable Fixation For “G” (#4146-5000) to the three (3) pegs on the “G” reference and tightening the thumb screw.

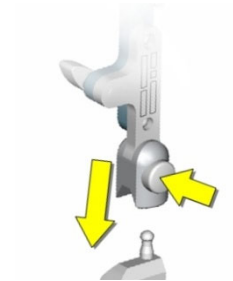



- If using the new “G” reference (NS-300G4) then it comes with the reattachable interface integrated.

- Use the push-release button on the “G” reference fixation to attach it to the navigation instruments.

4.4 Instrument calibration

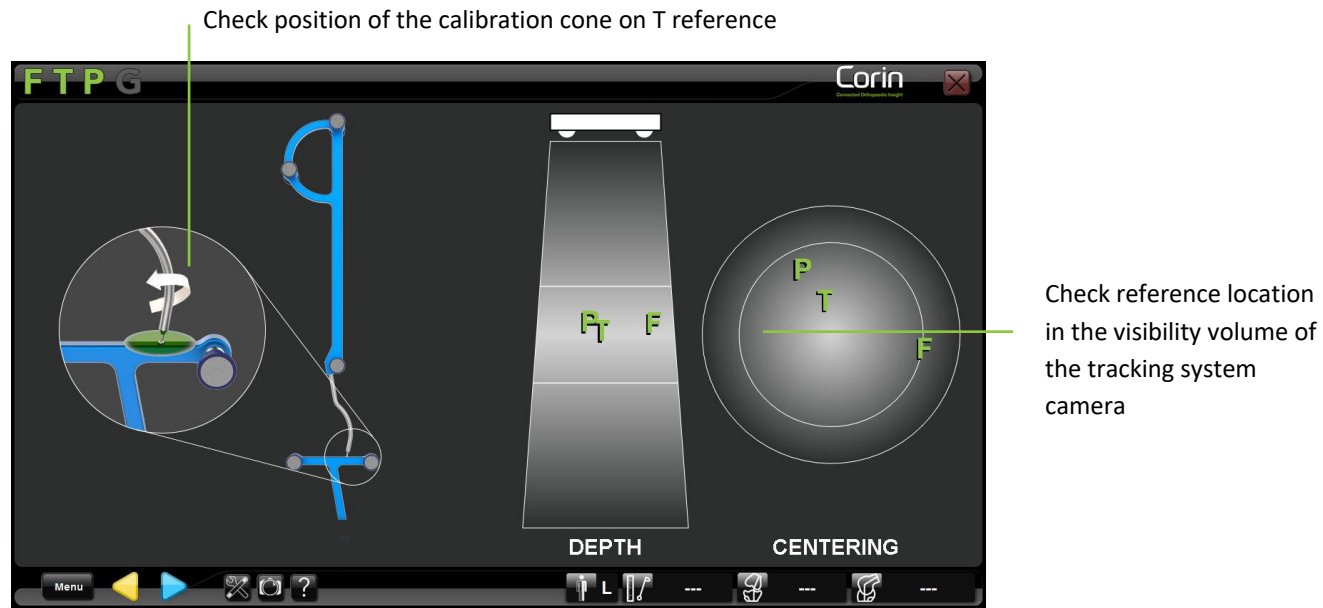

Calibrating the 3 markers Pointer:

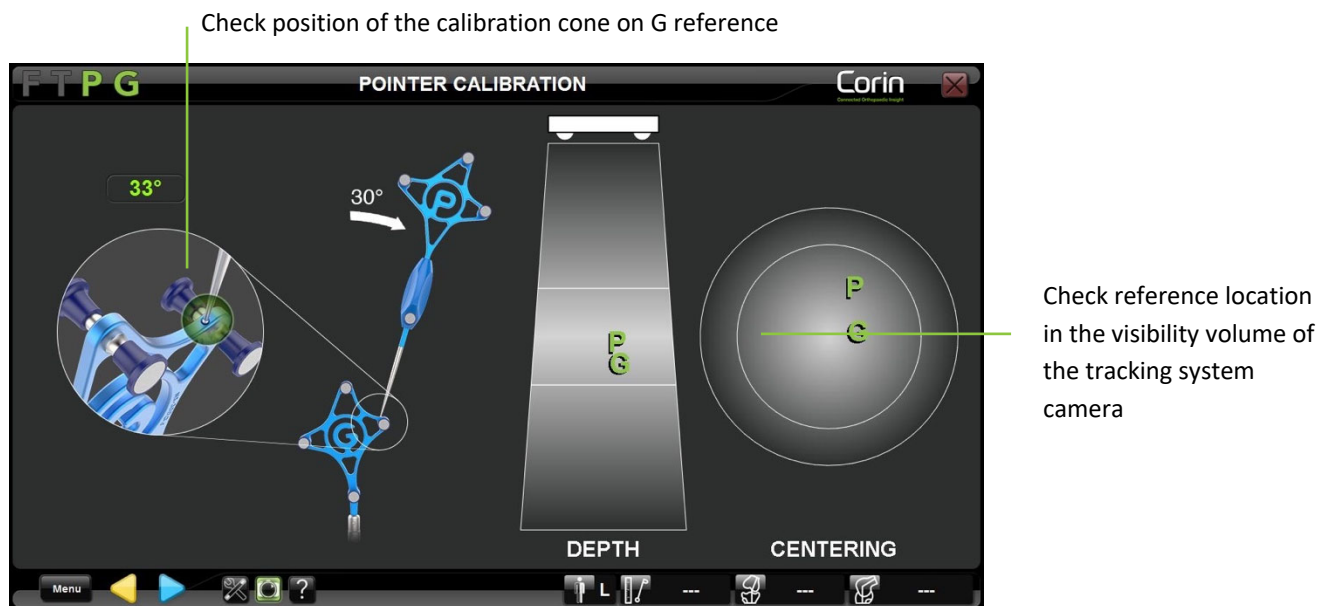

- Place the ball-tip of the Pointer (#0501-5000) into the calibration cone of the “T” reference (#0501-5030) and check that T and P are visible to the tracking system then touch  to calibrate the first side of the Pointer.
- Rotate the Pointer to face the other 3 markers toward the tracking system’s camera and check that T and P are visible then touch  to calibrate the second side of the Pointer.

Calibrating the 4 markers Pointer:



- Place the ball-tip of the Pointer (#NS-300P4) into the calibration cone of the “G” reference (#NS-300G4) and check that P and G are visible to the tracking system then touch  to calibrate the first position of the Pointer.
- Tilt the Pointer by at least 30° and check that P and G are visible then touch  to calibrate the second position of the Pointer.

Note: The software will detect if the Pointer tilt angle is at least 30° between the two positions. If this is not the case, then the calibration of the Pointer will be restarted automatically.

Calibrating tracked instruments:

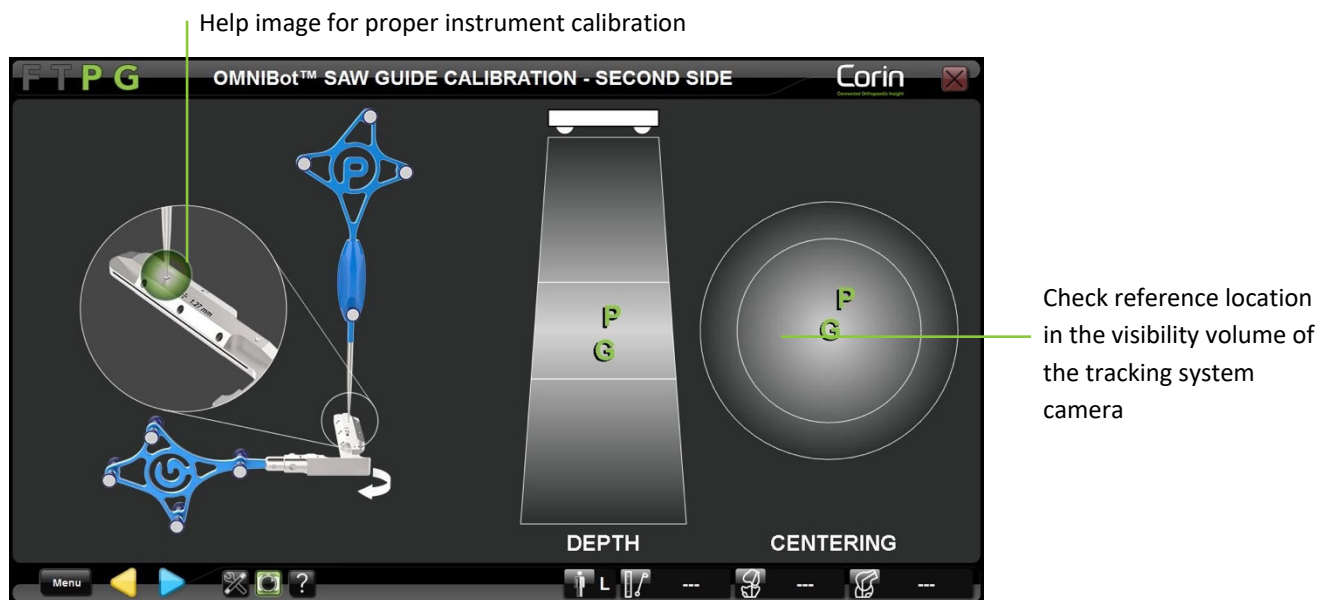

- Attach the “G” reference (#0501-5070, NS-3000G or NS-300P4) to the instrument displayed on screen.
- Place the ball-tip of the Pointer (#0501-5000 or NS-300P4) into the first calibration cone of the instrument and check that P and G are visible to the tracking system then touch  to acquire the first cone position.
- Repeat the above step until all four cones have been acquired.

Note: Calibrating any OMNIBot Saw Guide (#4146-5200, 4146-5300, XK-06471 or XK-06449) will require to repeat the four cones acquisition process twice to calibrate the instrument for each side of the “G” reference.



RECOMMENDATION:

- Do not push on or bend the Pointer during calibration.
- Angle the Pointer so that it is perpendicular to the surface of the instrument containing each cone during calibration.
- The ball-tip of the Pointer should be completely inside each cone during calibration.
- Instruments are centered in the visibility volume of the tracking system camera (depth and centering) and are square with the camera during calibration.
- Use the same side of the Pointer when calibrating an instrument.



WARNING: When calibrating the NanoBlock™ (#4137-5000), pay particular attention when digitizing the central cone adjacent to the push button of the Reattachable Fixation for “G”. Make sure that the ball-tip of the Pointer is completely inside the cone. Inaccurate calibration of this cone can lead to errors in tibial and femoral slope positioning.



WARNING: If any calibrated instrument must be replaced during the procedure then the accuracy of the replacement instrument is no longer guaranteed. The replacement instrument must be recalibrated before being used (See §5.4).

4.5 References and Camera positioning

General recommendations for quick fixing cortical screws

- Required instruments

The following instruments are required to use the screws:

- Pin Driver (#4148-2000 or NS-40300)
- Power drill for insertion of bone screws

- Screw insertion

Attach the Pin Driver to the Power Drill to insert the screw. Choose a screw with the appropriate length for the patient's anatomy. Insert the screw in the Pin driver and drill the screw into the bone. Pull the drill to detach it from the screw once it is sufficiently inserted into the bone. The system is used in the same way to remove the screws.



WARNING: The use of a bone fixation requires the consideration of all the risks associated with this type of device, in particular those regarding the quality of the bone.



RECOMMENDATION:

- OMNI recommends the use of OMNIBotics pins and screws.
- The system can be used in the incision or percutaneously. If the system is used percutaneously, ensure that you prepare the skin in accordance with your usual method.

- Usage restriction



WARNING: Use with a low-speed drill. The screws must not be used if any deformity, signs of damage or an abnormal wear and tear, particularly on the tip, is detected. Such defects may cause the screw to become irreversibly blocked or seized within the instrument that it is intended to be used with.

- Prion risk



WARNING: If there is a risk that the patient is infected with Creutzfeldt-Jacob disease, the screws must be disposed of appropriately.

Attaching bone references to the patient:

The “F” and “T” references must be securely attached onto the femur and tibia, respectively, in such a way that they are visible to the navigation Station camera throughout the range of knee motion. *Tip:* Align the T and F references with the sagittal plane of each bone. Orient the arrays to the camera with the leg in mid-flexion and check the visibility throughout the entire range before proceeding with the acquisitions.

Ø3.2mm and Ø4.0mm Bone Screws are for bi-cortical use on the tibia and femur are intended to be driven into but not beyond the far cortex for optimal stability.



WARNING: Do not use the instrument if any looseness is detected between the different components once the assembly has been locked together.

- **Placement of the “T” reference:** Using the Two Pin Fixation (#4149-5000) and the Universal Reattachable Joint (#4154-5000) illustrated below.

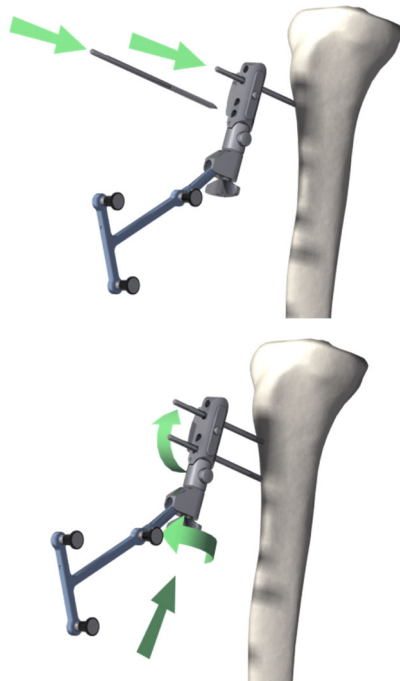

Place the first 3.2mm Bone Screw (#4148-1004 or #4148-1005) approximately 10cm below the tibial plateau using the Multi Diameter Pin Driver (#4148-2000 or NS-40300). Evaluate the placement to avoid conflict with the cuts and cutting block.

The placement of the second screw can be done using the Two Pin Universal Fixation (#4149-5000) as a drill guide. For improved stability, leave at least one hole between the two screws.

Secure the Two Pin Universal Fixation (#4149-5000) manually on the two screws by tightening the thumbscrew. It is important that the bone screws have solid bone fixation and the Two Pin Universal Fixation is firmly clamped onto the screws. Attach the “T” reference (#0501-5030 or NS-300T4) to the Two Pin Universal Fixation using the Universal Reattachable Joint Ø6.9mm Adaptor (# 4154-5000). Orientate the optical markers of the tibial reference toward the Station camera and tighten the thumbscrew on the adaptor.

In the presence of soft bone, a Ø4.0 mm Bone Screw (#4148-1001 or #4148-1002) is available to gain additional stability.

- Placement of the “T” reference when using the BalanceBot:** Using the Two Pin Fixation (#NS-06827) with the Universal Reattachable Array Holder (#NS-06864) illustrated below will avoid conflict with the BalanceBot body during active ligament balancing (See §4.10) or during final stability assessment (See §4.19)

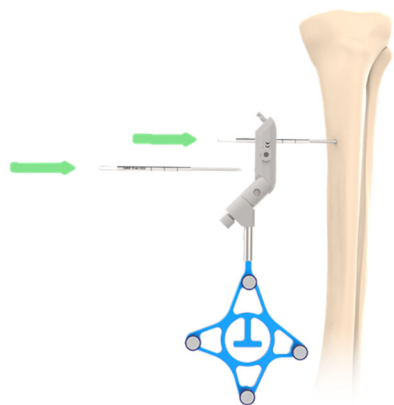

For use with the BalanceBot, place the first \varnothing 3.2mm Bone Screw (#4148-1004 or 4148-1005) either medially, or approximately 15-20cm below the tibial plateau using the Pin Driver (#4148-2000 or NS-40300). Evaluate the placement to avoid conflict with the BalanceBot.

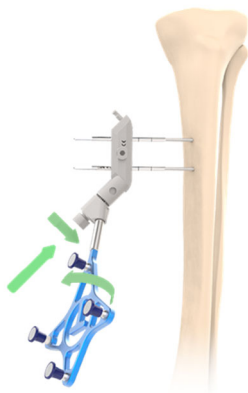

Secure the Two Pin Fixation (#NS-06827) using the 5mm Hex screw driver (#KS-31000). It is important that the bone screws have solid bone fixation and the Two Pin Universal Fixation is firmly clamped onto the screws. Attach the “T” reference (#0501-5030 or NS-300T4) to the Two Pin Fixation using the Universal Reattachable Array Holder (#NS-06864). Orientate the optical markers of the tibial reference toward the Station camera and tighten its locking screw.

- **Placement of the “F” reference when using the NanoBlock™:** use a two-pin fixation (#4149-5000 or NS-06827) and a universal reattachable holder (#4154-5000 or NS-06864) illustrated below.

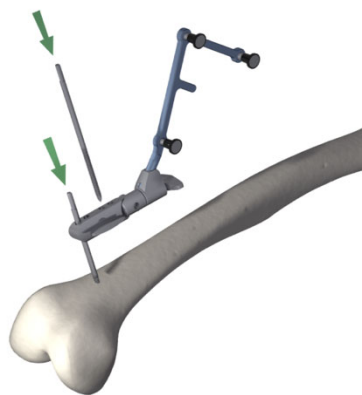

Place the first Ø4.0mm Bone Screw (#4148-1001 or #4148-1002) in the metaphyseal or diaphyseal area of the distal femur using the Pin Driver (#4148-2000 or NS-40300). Screws can be placed in the incision if transepicondylar or percutaneously if diaphyseal. Evaluate the placement to avoid conflict with the cuts and cutting block.

The placement of the second screw can be done using a two-pin fixation (#4149-5000 or NS-06827) as a drill guide. For improved stability, leave at least one hole between the two screws.

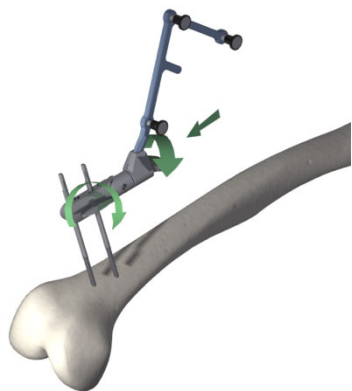

Secure the two-pin fixation (#4149-5000 or NS-06827) with its locking screw. It is important that the bone screws have solid bone fixation and the Two Pin Universal Fixation is firmly clamped onto the screws. Attach the “F” reference (#0501-5020 or NS-300F4) to the two-pin fixation using a universal reattachable holder (# 4154-5000 or NS-06864). Orientate the optical markers of the femoral reference toward the Station camera and tighten its locking screw.

- **Placement of the “F” reference when using the OMNIBot™:** use the OMNIBot Fixation Base (#4145-5100 or NS-06762) and the 45° Angled Reattachable Adaptor (#4154-5100) illustrated below.

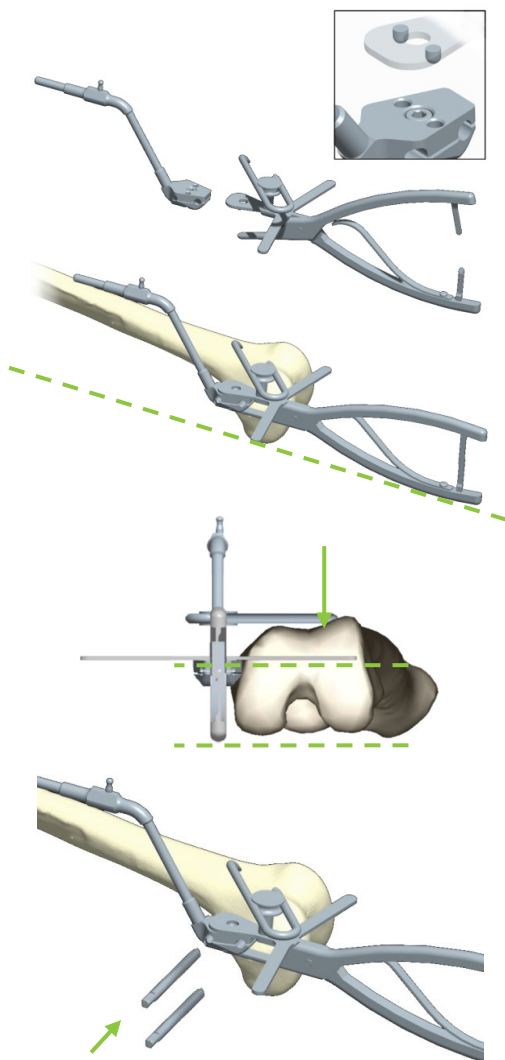

1. Place the OMNIBot Fixation Base (#4145-5100 or NS-06762) between the jaws of the Positioning Clamp (#4145-3100). Close the clamp and engage the locking teeth.
2. Position the OMNIBot Fixation Base against the medial aspect of the distal femur, with the wing of the clamp in contact with both distal condyles; the drill guide just anterior to the attachment of the medial epicondyle.
3. Point the fixation base stem towards the femoral head of the hip in the frontal and the sagittal plane.
4. Align the wing of the clamp in the axial plane with the transepicondylar or posterior condylar axis. This will align the pins with the femoral resections in the sagittal plane.
5. Slide and rotate the stylus on the clamp so that the tip is in contact with the center of the anterior cortex, in the area of the implant apex. This will position the screws posterior to the anterior resection.
6. Taking into account the quality of bone and the size of femur, select the appropriate position and length of Cancellous Bone Screws (#4145-5003 or #4145-5004). Using a power drill equipped with the Pin Driver (#4148-2000 or NS-40300), insert the Cancellous Bone Screws by drilling them until they disengage from the socket and are completely inserted into the OMNIBot Fixation Base. Only a small portion of the screw ends should be protruding out of the fixation base.
7. Remove the clamp.

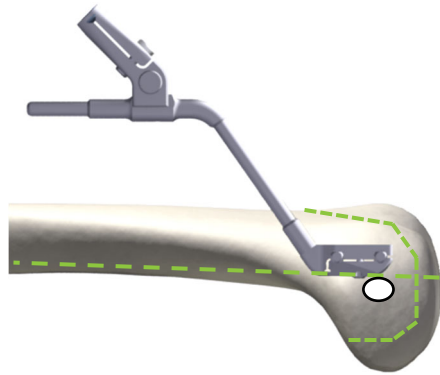

Note: The Cancellous Bone Screws should not intersect any of the femoral resection planes and they should enter the bone just anterior to the femoral mid-sagittal plane i.e. approximately 5mm anterior to the anterior margin of the MCL insertion site on femur.



RECOMMENDATION: The Cancellous Bone Screws should be placed in the frontal plane.

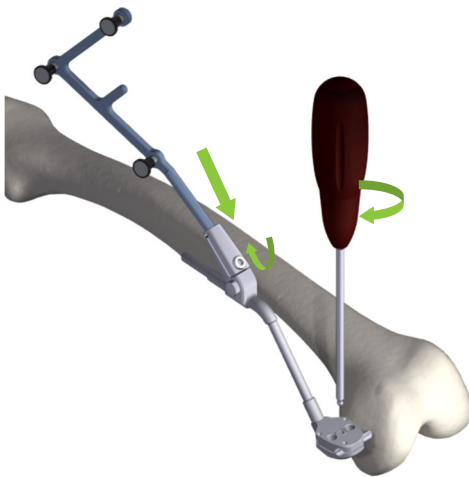

Tighten the OMNIBot Fixation Base (#4145-5100 or NS-06762) with the H3.5 screwdriver (#KS-62030).

Attach the “F” reference (#0501-5020 or NS-300F4) to the fixation base with the 45° Angled Reattachable Adaptor (#4154-5100). Orientate the optical markers of the femoral reference toward the Station camera and tighten the screw to fix the reference in position using the H3.5 screwdriver.

Note: It is possible to replace the 45° Angled Reattachable Adaptor (#4154-5100) with a universal reattachable array holder (# 4154-5000 or NS-06864).

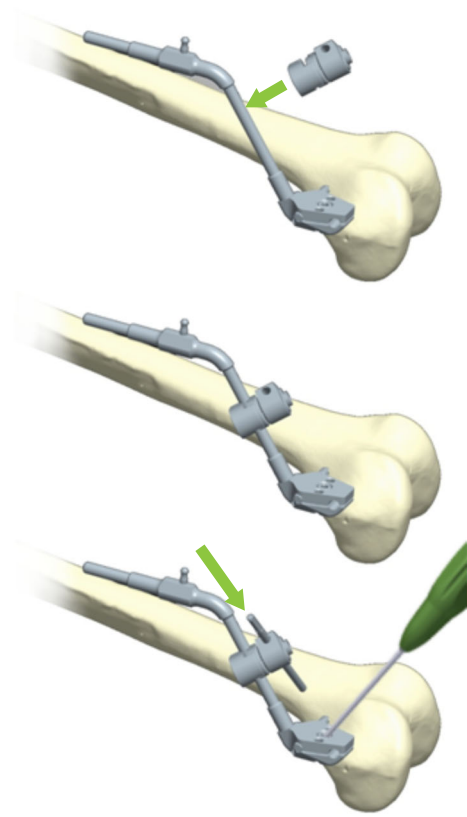

If it is necessary to improve fixation stability with an additional pin (in the case of poor fixation stability, or poor bone quality), attach a $\varnothing 6 \times \varnothing 4$ Articulated Connector (#4145-1030) on the shaft of the OMNIBot Fixation Base (#4145-3100 or NS-06762) and orient it according to desired pin direction. Insert a 4mm diameter cortical bone screw (#4148-1001 or #4148-1002) through the hole and into the femur. Tighten the articulation with the H3.5 screwdriver and check the stability of the fixation in the bone.



RECOMMENDATION: The screw on the $\varnothing 6 \times \varnothing 4$ Articulated Connector is not removable. When loosening the screw, do not force it passed the limit or there will be a risk of damaging the product.

Locating the patient references:

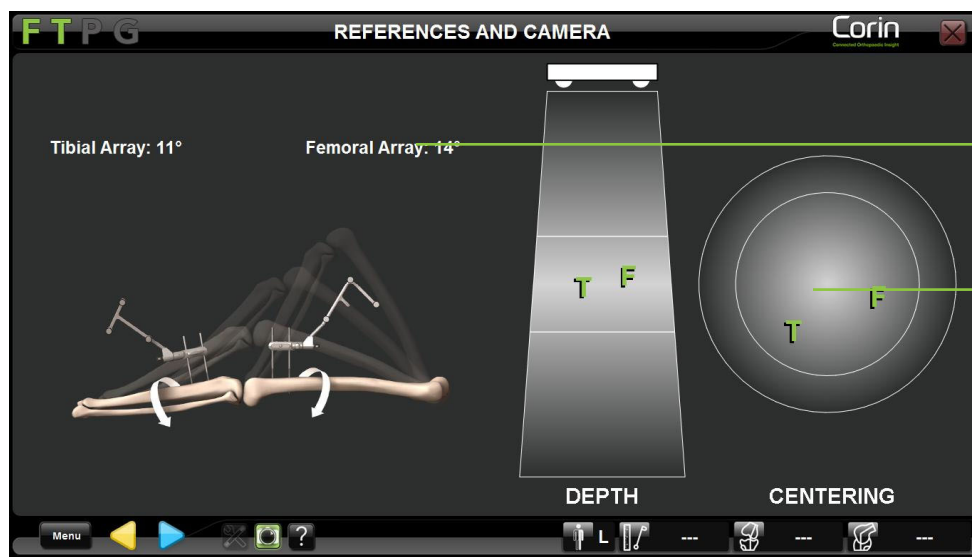

Check reference orientation relative to the tracking system camera line of sight

Check reference location in the visibility volume of the tracking system camera

- Check visibility and orientation of “F” and “T” references on the screen in maximum flexion and in extension. Adjust the orientation of the references as necessary and proceed. “F” and “T” angle to the camera should be less than 20°.
- Touch  to validate “F” and “T” references’ position.

Note: “F” and “T” references must be securely attached to the Femur and Tibia and visible to the system when touching  to proceed to the next stage. The relative position of “F” and “T” references is registered and the information used for subsequent automated controls (e.g. amplitude of the Hip Center Acquisition movement and determination of medial/lateral acquisitions).



WARNING: The “F” and “T” references must be securely attached to the femur and to the tibia, respectively during “References and Camera” step. If the references are moved after this stage, all patient registration must be reperfomed.

4.6 Patient Anatomy Registration

Acquiring the hip center:

Check help image for proper kinematic registration



- Touch  to start hip center acquisition.
- Rotate the femur to perform the acquisition. The diameter of rotation around the femoral reference must be at least 15 cm. The acquisition will complete automatically.





RECOMMENDATION: During the determination of the hip center, make circular movements with the leg. Make sure that the patient's pelvis and the Station's localizer do not move during this acquisition.

Acquiring the ankle center:

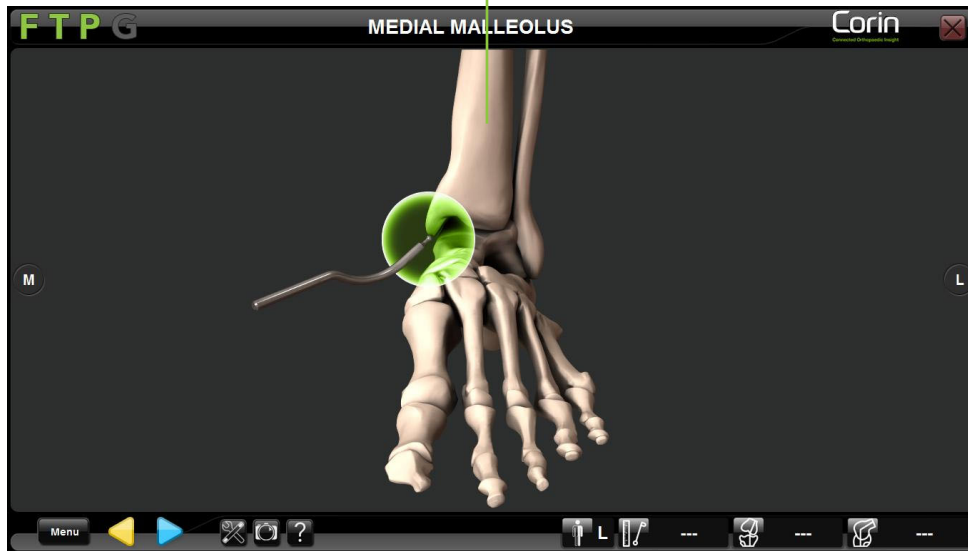
Check help image for proper side registration



- Place the ball-tip of the Pointer on the most distal point of the medial malleolus.
- Touch  to register the position of this first point.
- Place the ball-tip of the Pointer on the most distal point of the lateral malleolus
- Touch  to register the position of the second point.

Note: The system uses the middle of the lateral and medial malleolus to determine the center of the ankle.

Acquiring the ankle center using the Manual Adjustment feature:

The Manual Adjustment feature can be activated by accessing the USER PROFILE SETTING menu, under the ACQUISITION sub menu.

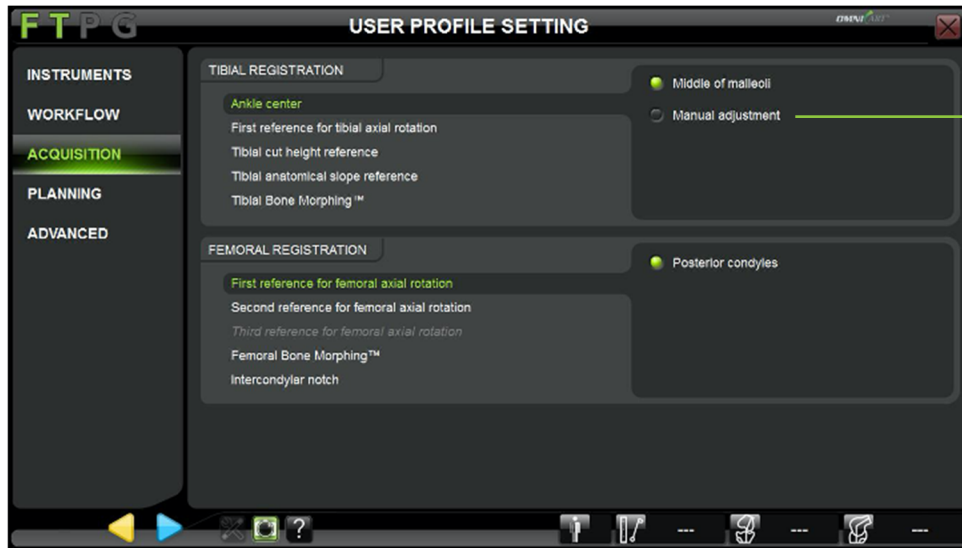

Click option to activate manual adjustment.

- Acquire the medial and lateral malleoli as described above.
- The midpoint of the lateral and medial malleoli is represented by a yellow circle.
- While moving the ball-tip of the Pointer between the 2 previously acquired points, a colored circle will move on the line joining the acquired medial and lateral malleoli points.

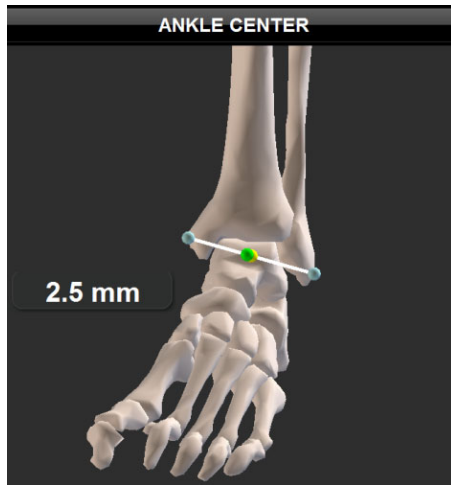

If the ball-tip position is within 4mm of the center of the ankle, it will be displayed in green.

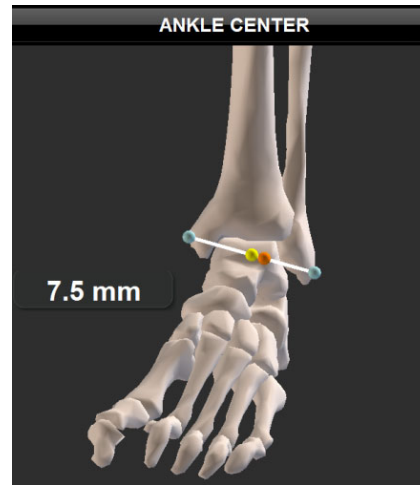

If the ball-tip position is ≥ 4 mm from the center it will be displayed in orange

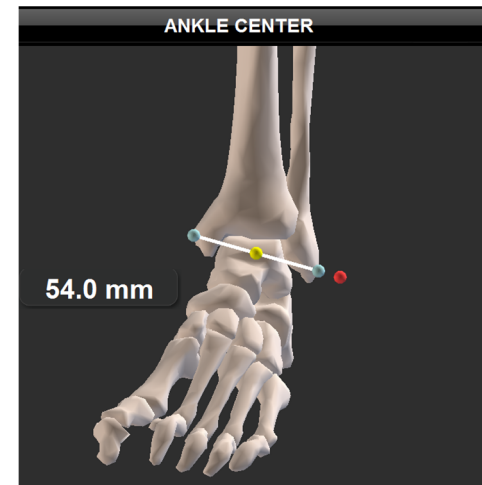



If the ball-tip position is outside of the medial and lateral malleoli, it will be displayed in red

- Touch  to validate to manual ankle center adjustment.

Acquiring anatomical points:

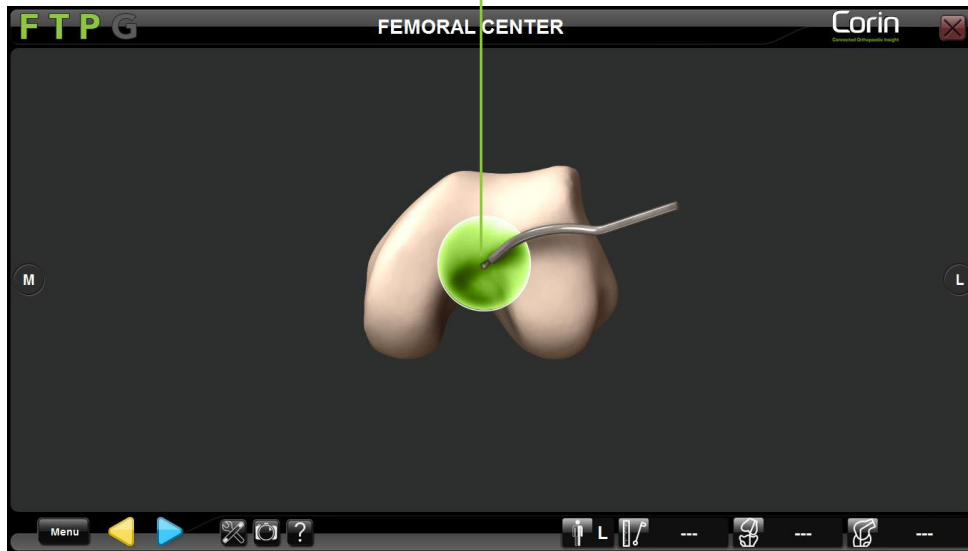
Check help image for proper anatomical point registration



- Place the ball-tip of the Pointer on the point displayed on screen.
- Touch  to register the position of this point.

Note: It is important to keep the ball-tip of the Pointer in constant contact with the bone during point acquisition.

Note: The anterior tibial tuberosity (ATT) is used as a reference to determine the axial rotation axis of the tibia. An error in the ATT registration will result in an offset in the tibiofemoral rotation values (for more details see §4.21)

Acquiring anatomical surfaces when using “Light” OMNIBotics Bone Morphing™ (Tibia and Femur):

Check help image for proper anatomical surface registration

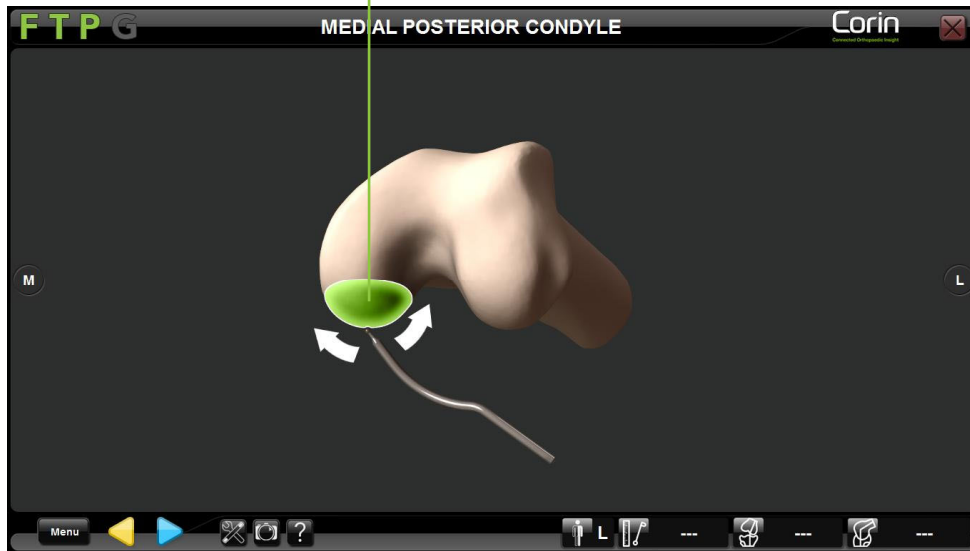



- Place the ball-tip of the Pointer on the anatomical surface displayed on screen.
- Touch  to start Bone Morphing acquisition
- Glide the ball-tip of the Pointer on the local surface until the green bar fills up and acquisition completes automatically.

Note: Focus on acquiring a large surface area as opposed to gathering many points in a small concentrated area. It is important to keep the ball-tip of the Pointer in constant contact with the bone during morphing acquisition.

	<p>RECOMMENDATION: It is important not to include osteophytes during Bone Morphing acquisitions. Therefore, it is recommended to remove osteophytes before starting the Bone Morphing surface acquisitions process.</p>
	<p>RECOMMENDATION: It is necessary to cover important areas such as the most distal and posterior portions of the condyles and lateral ridge of the anterior cortex. Pay particular attention when acquiring points on a large knee or a knee with significant defects as more points can be required to include significant landmarks.</p>

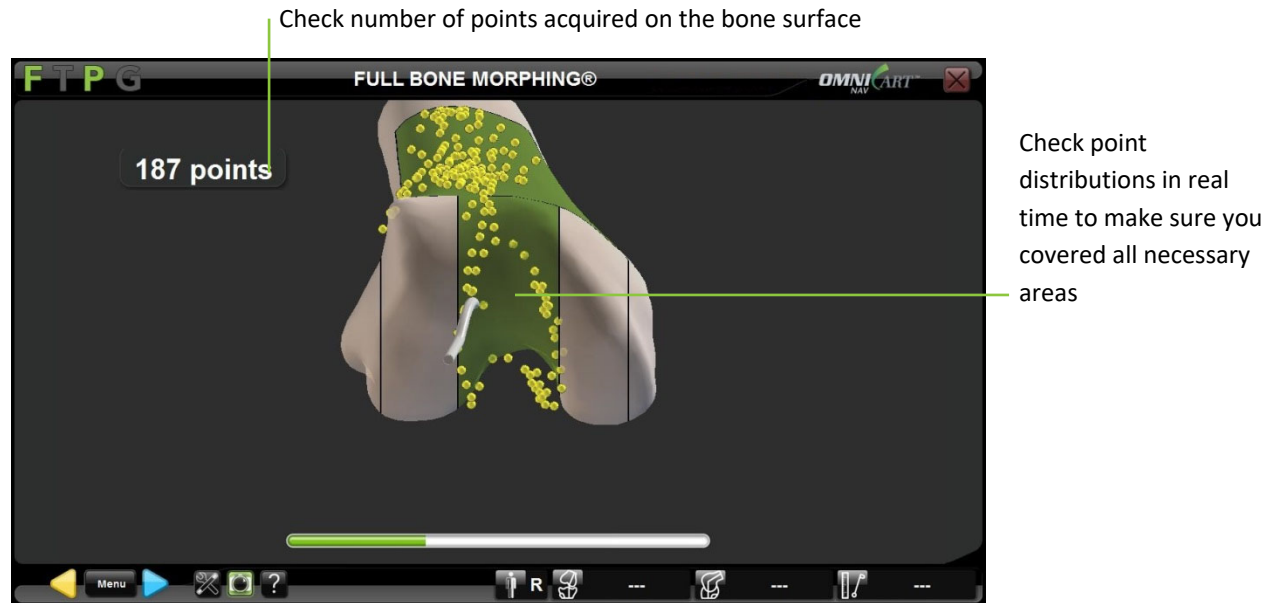
Acquiring anatomical surfaces when using “Full” OMNIBotics Bone Morphing™ (Femur only):



- Place the ball-tip of the Pointer on the Distal Femur.
- Touch  to start Bone Morphing acquisition.
- Glide the ball-tip of the Pointer over the entire distal femur until each area becomes green and acquisition completes automatically. It is also possible to manually complete the acquisition by touching  as soon as 500 points have been collected.

Note: Focus on acquiring large surface areas as opposed to gathering many points in small concentrated areas. It is important to keep the ball-tip of the Pointer in constant contact with the bone during morphing acquisition.



RECOMMENDATION: It is important not to include osteophytes during Bone Morphing acquisitions. Therefore, it is recommended to remove osteophytes before starting the Bone Morphing surface acquisitions process.

4.7 OMNIBotics Bone Morphing™ validation

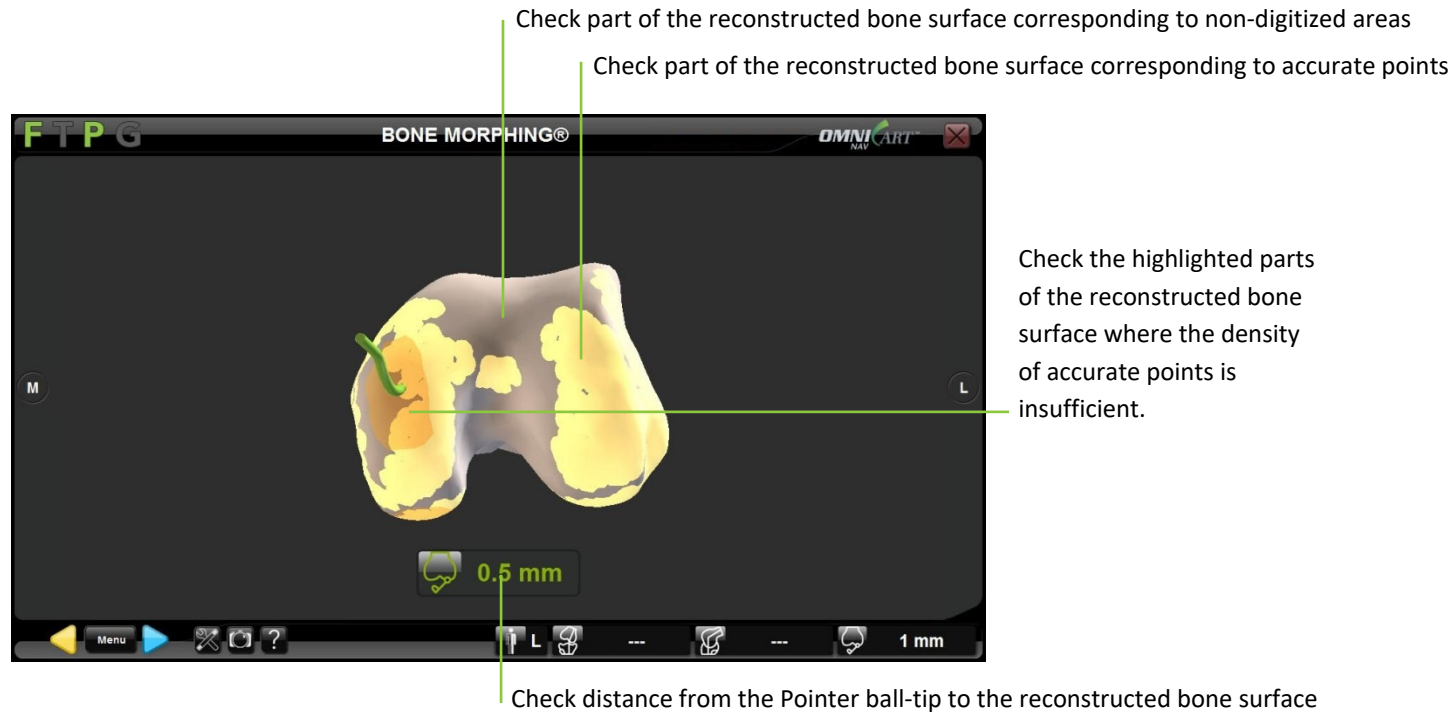

Validating the Bone Morphing reconstruction:



- Place the ball-tip of the Pointer on the part of the bone you want to check. The value indicated on the screen below the bone model represents the distance between the pointer tip and the bone model. Check that the distance is less than or equal to 1.0mm in these key areas.
- Touch  to validate the generated 3D model of the bone.

Note: To help detect and avoid Anterior Cortex notching the system can require extending the Bone Morphing™ proximally in this area before reaching the OMNIBotics Bone Morphing™ validation page. In this case, the notification message will provide a shortcut to go directly to the “Bone Morphing Add Points” step (See section “**Adding points to the OMNIBotics Bone Morphing™**” below).

Adding points to the OMNIBotics Bone Morphing™:

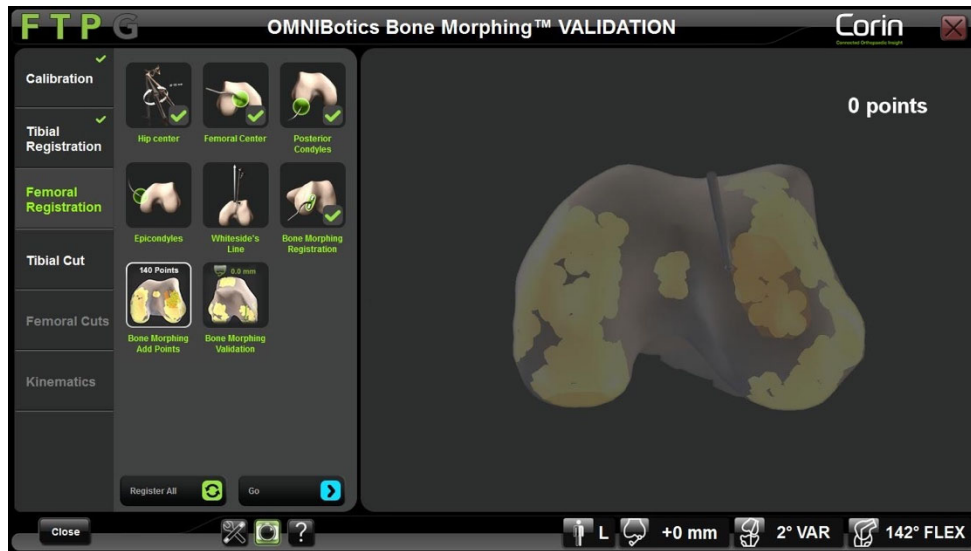
- From the Bone Morphing validation page touch  to open the Menu and select the appropriate “Bone Morphing Add Points” tab.



- Touch  to go to selected “Bone Morphing Add Points” step.
- Touch  to start the additional point acquisition.

Note: It is important to keep the ball-tip of the Pointer in constant contact with the bone during morphing acquisition.

- Touch  to stop the additional point acquisition.

Note: If the system required extending the Bone Morphing™ proximally the shortcut in notification message will lead directly to the “Bone Morphing Add Points” step and a red zone at the level of the femoral anterior cortex will indicate how more proximal points must be acquired as illustrated below:

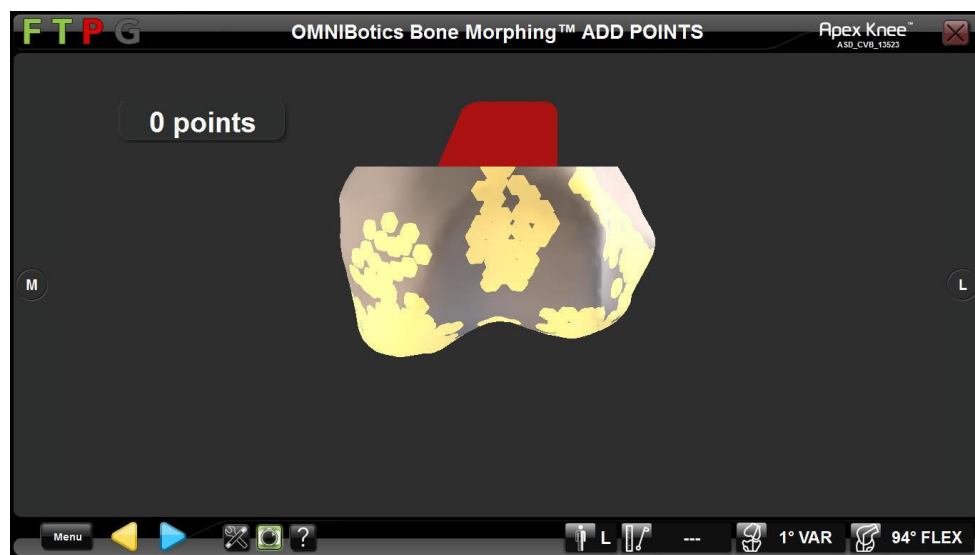

4.8 Tibial planning with Tibia OMNIBotics Bone Morphing™

Note: Tibia planning is available only if the Tibia Bone Morphing option is selected in profile options – Refer to §5.3.

Size and position for the tibial implant is proposed based on the Bone Morphing model previously generated. The default cut is a 10mm resection from the least affected side of the tibial plateau. For more details about predefined profiles refer to §5.2.

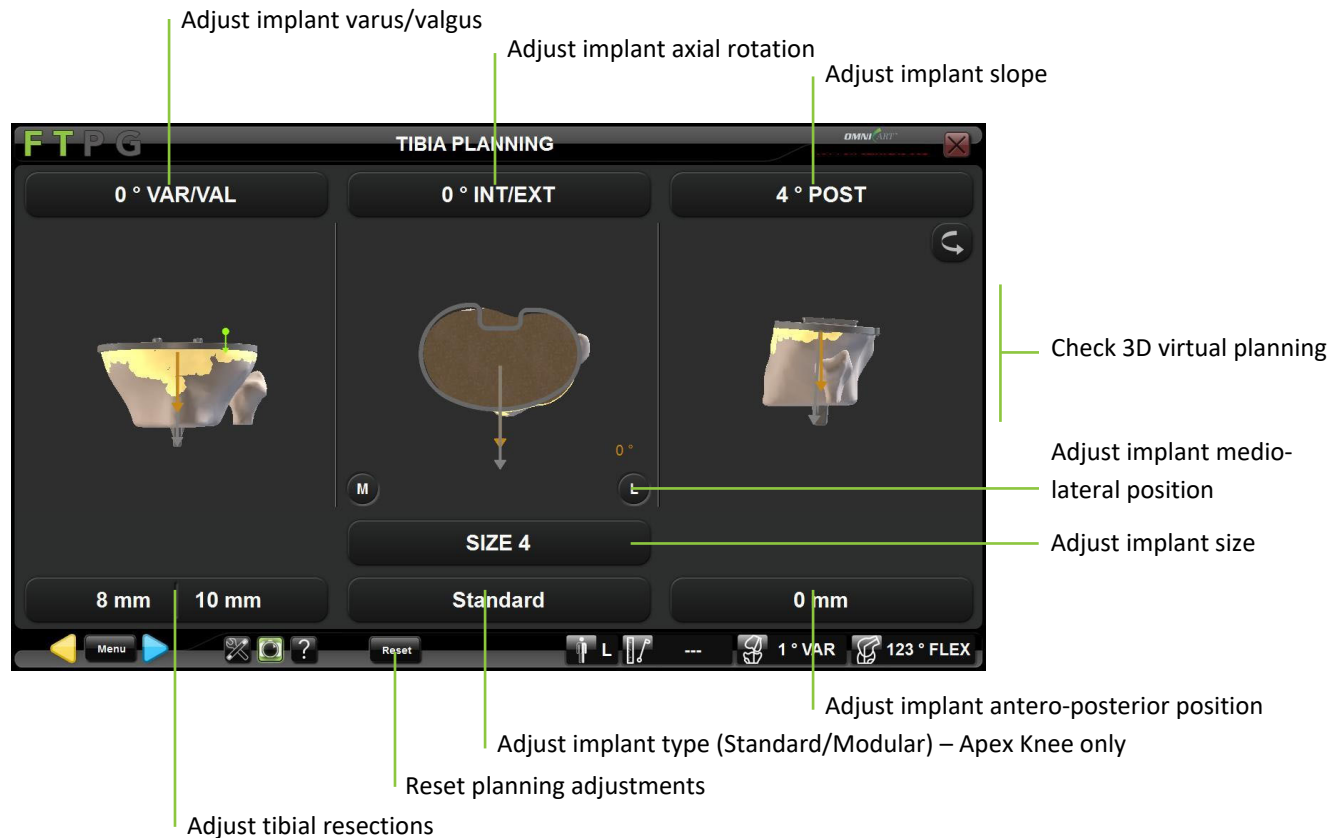

Select implant type – Apex Knee only: If needed, touch the “Standard” button then touch </> to change the implant type to “Modular”.

Note: Selecting the Modular tibia implant for Apex Knee will automatically default the Tibial Slope to 0° and the Tibial Resection to +2mm.

Adjust tibia implant position: Touch the parameter button to be adjusted then touch +/-.

Adjust tibia implant size: Touch “SIZE” button then touch +/-.

Reset tibial planning adjustments: Touch  .

Confirm the Tibial Navigation Plan: Touch  .

4.9 Femoral Planning

Size and position for the femoral implant is proposed based on the OMNIBotics Bone Morphing™ model previously generated and specifics of the implant used. The default cuts are equal to the thickness of the femoral component. The default femoral component rotation is 3° with respect to the posterior condyles. For more details about predefined profiles for each implant refer to §5.2.

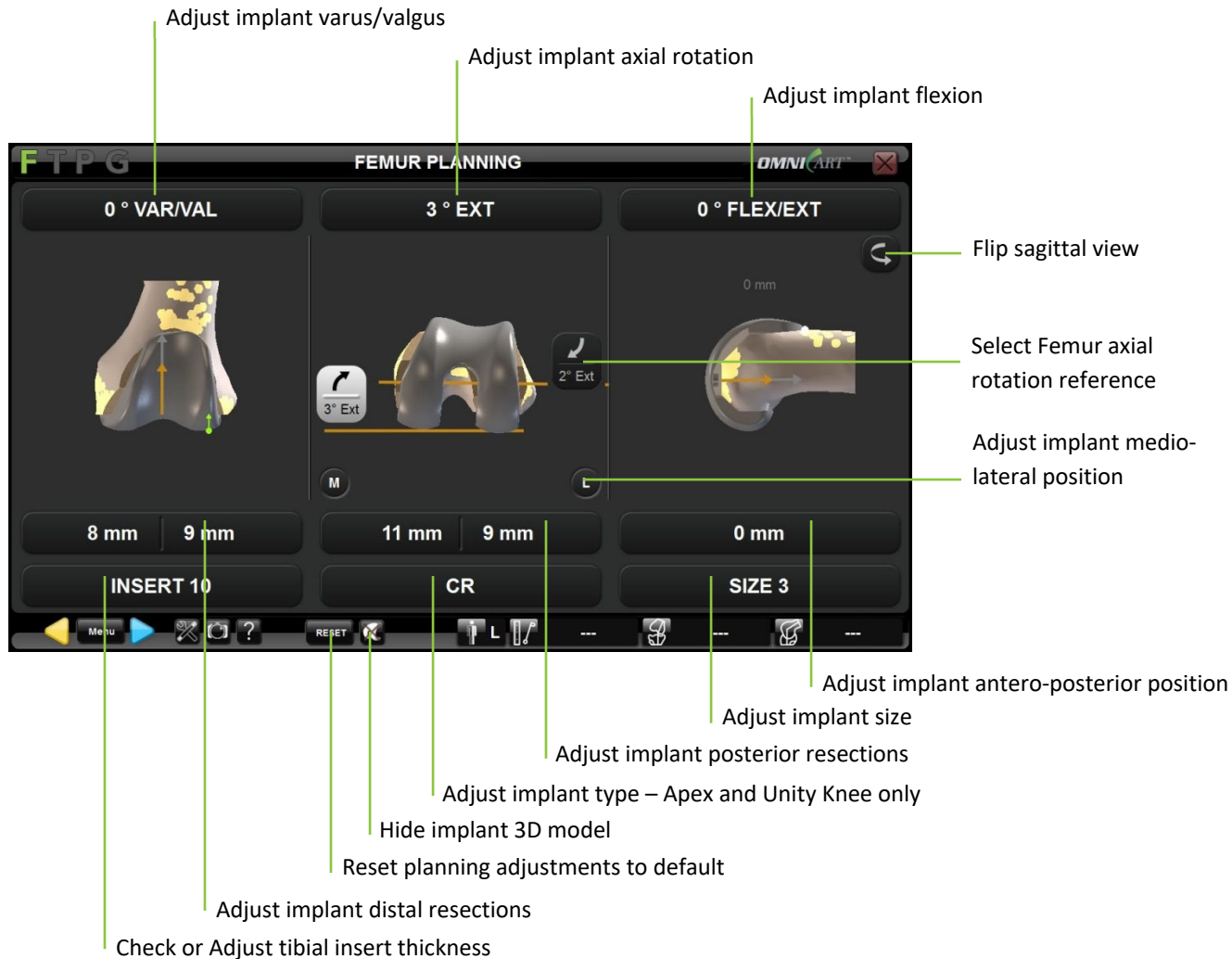

Hide 3D implant model and view corresponding cuts: Touch  .

Note: Touch  again to view the implant 3D model.



Adjust femur implant position: Touch parameter button to be adjusted then touch +/-.

Adjust femur implant size: Touch “SIZE” button then touch +/-.

Adjust implant type – Apex and Unity Knee only: Touch “CR” or “PS” button then touch </>.

Reset femoral planning adjustments and return to default settings: Touch  .

Confirm the Femoral Navigation Plan: Touch  .

	RECOMMENDATION: The femoral planning must be controlled and optimized by the surgeon, based on the patient anatomy and 3D information available at the femoral planning step.
	RECOMMENDATION: Femoral Component Rotation should be optimized using multiple references, including the: <ul style="list-style-type: none">• Anterior Posterior axis (Whiteside’s Line),• Transepicondylar axis,• Posterior Condylar axis and resection depths,• Shape of the anterior resection contour, and the• Degree of pre-operative patient deformity, condylar wear and symmetry of the flexion gap. <p>Note: Adjustment of femoral rotation may influence the desired femoral component size. The surgeon should re-evaluate the femoral component size after adjusting femoral rotation to ensure optimal fit.</p>



RECOMMENDATION: When using the posterior referencing option, ART planning software will initially propose a larger femoral component size if the Anterior Resection value is greater than 1.0mm POST. For certain patient anatomies, especially for femurs with a narrow ML to AP aspect ratio, this may result in a larger than desired femoral component size. The surgeon should evaluate a smaller size by manually reducing the size and adjusting the component position as necessary while visualizing the resection contours. Femoral component flexion and/or AP translation may be adjusted to achieve the optimal component fit.

4.10 Femoral Planning with Ligament Balancing

Note: Select the Ligament Balancing profile without the BalanceBot™ option (see §5.2 and §5.3). The steps described below are immediately following Tibial Cut Navigation.

Record ligament balance in extension:

- Place the leg in full extension and tension the ligaments using an adapted device (asymmetric spacer or distracting device) in order to stabilize the knee.
- Check the knee stability and the leg alignment in both the frontal and the sagittal plane.
- Test stability in stressed varus and stressed valgus and note the gap variation of the two compartments.

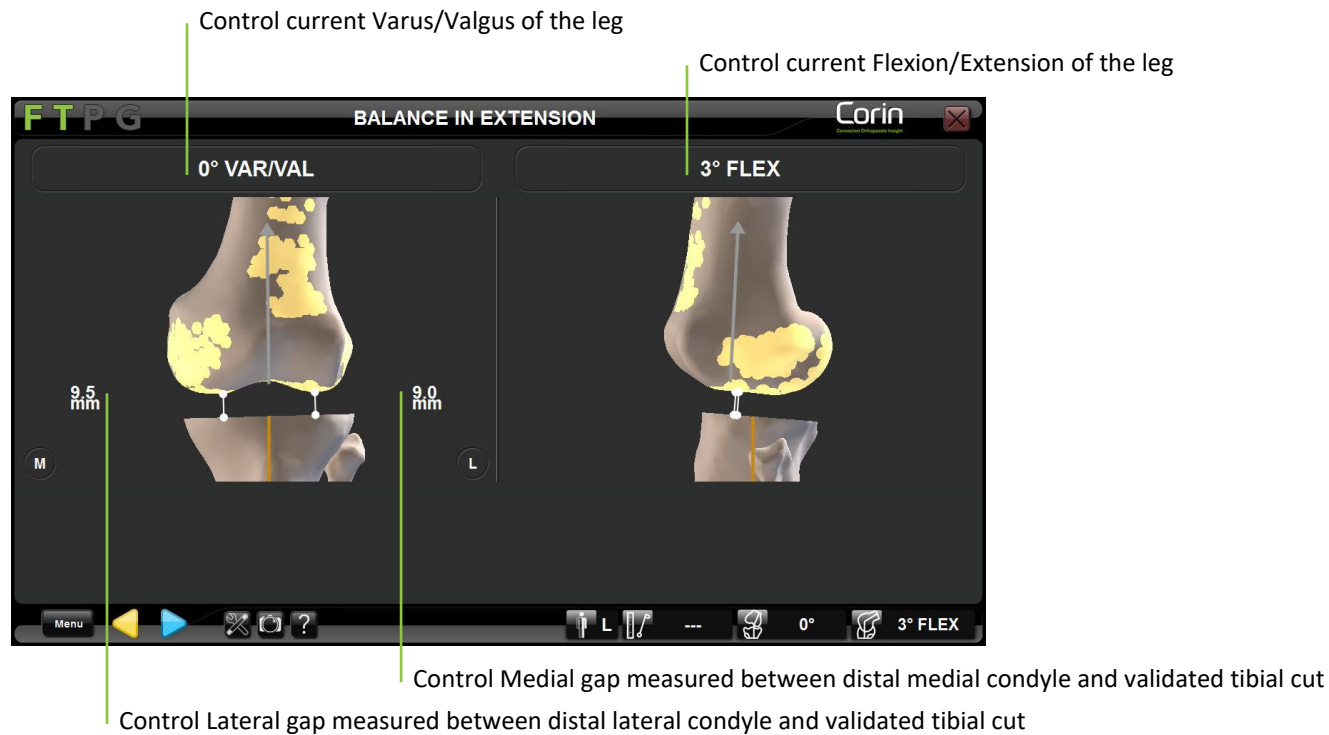

Register the extension gaps: Touch  .

Record ligament balance in flexion:

- Place the leg at 90° of flexion and tension the ligaments using an adapted device (asymmetric spacer or distracting device) in order to stabilize the knee.
- Check the knee stability and control axial rotation that will be induced to the femoral implant to have a posterior cut parallel to tibial cut at 90° of flexion.
- Test stability in stressed varus/valgus and note the gap variation of the two compartments.

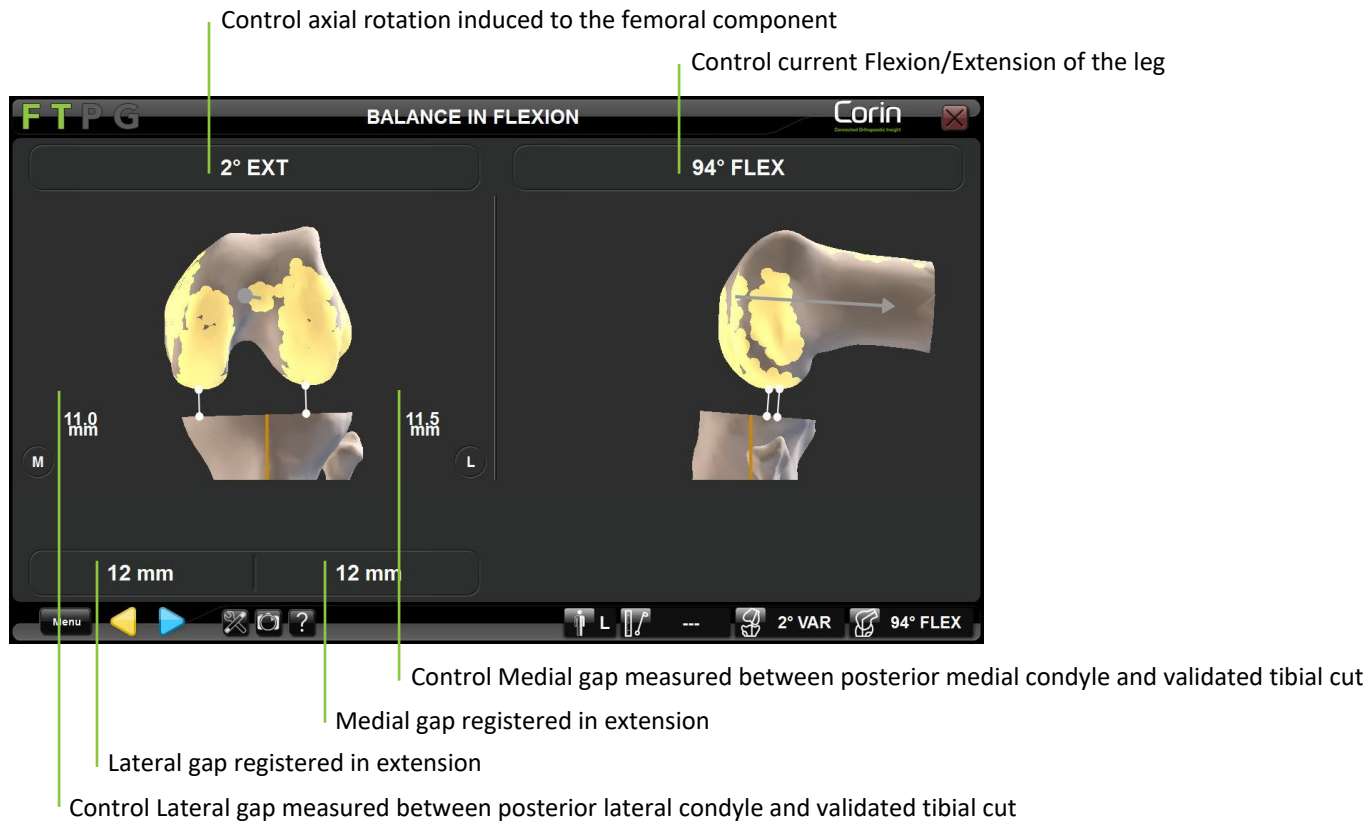

Register the flexion gaps: Touch  .

Adjust Femoral Planning:

Size and position for the femoral implant is proposed based on the OMNIBotics Bone Morphing™ model previously generated and specifics of the implant used. In this case the preferred method of establishing rotation is to rotate the femoral component to be parallel to the Tibial Cut while respecting anatomical limits for implant placement. In addition, gap information is shown corresponding to the simulated implant position and flexion/extension gaps previously recorded.

Note: The extension and flexion position displayed on the screen correspond to the two reference positions recorded previously. These positions should correspond to stable and correctly aligned positions of the knee. It is usually necessary to adjust the size and the position of the femoral component to achieve equal gaps (medial/lateral/extension/flexion) in order to obtain the same stability with the final implant as during ligament balancing steps.

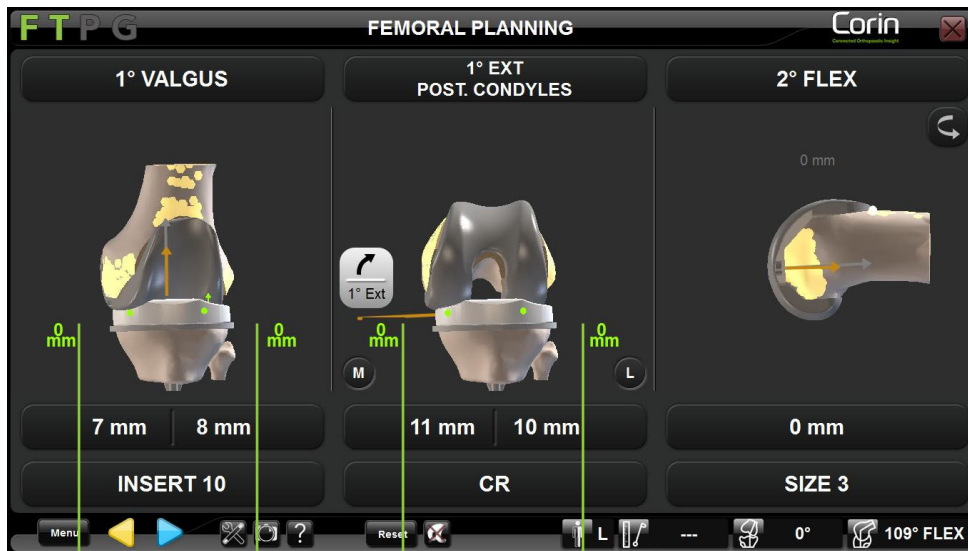

- Control Medial gap in flexion (Implant gap and/or Resection gap)
- Control Lateral gap in flexion (Implant gap and/or Resection gap)
- Control Medial gap in extension (Implant gap and/or Resection gap)
- Control Lateral gap in extension (Implant gap and/or Resection gap)

Note: The user can choose to display the distance between tibial insert and femoral component (“Implant gap”), distance between proximal tibial cut and distal/posterior femoral cuts (“Resection gap”), or both.

When choosing to display both “Implant gap” and “Resection Gaps”, touch  to switch back and forth between the two options.

4.11 Femoral Component Fit Adjustment – Apex Knee only

Femoral Component Fit Adjustment function modifies the planned relative locations of the anterior and posterior resections by the specified amount (-0.25mm, -0.5mm, -0.75mm) such that less bone is removed relative to the default setting.

See Figure below:

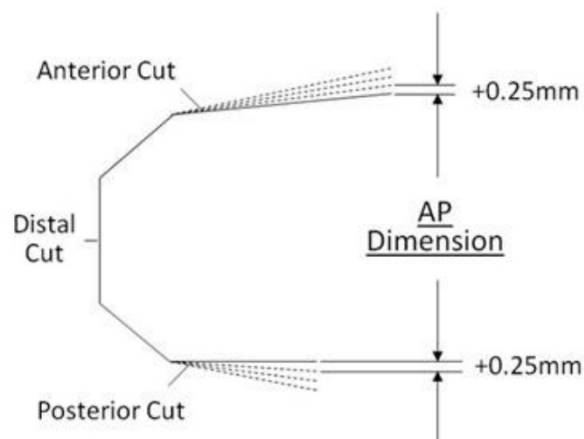

Fit adjustment adjusts the relative position of the targeted anterior and posterior resections in increments of 0.25mm at their most proximal point. The solid and broken lines represent the default (line-to-line) and adjusted locations, respectively

This function is enabled in the user profile settings and requires the use of the OMNIBot™. It is available for the Apex Knee only. Once enabled, the Femur Component Fit Adjustment can be modified intraoperatively during the following steps:

- Femoral planning.
- Distal Cut.
- Anterior cut if the anterior cut is navigated before the posterior cut.
- Posterior cut if the posterior cut is navigated before the anterior cut.

Femoral Component Fit adjustment during Femoral Planning: Touch fit parameter button then touch +/-

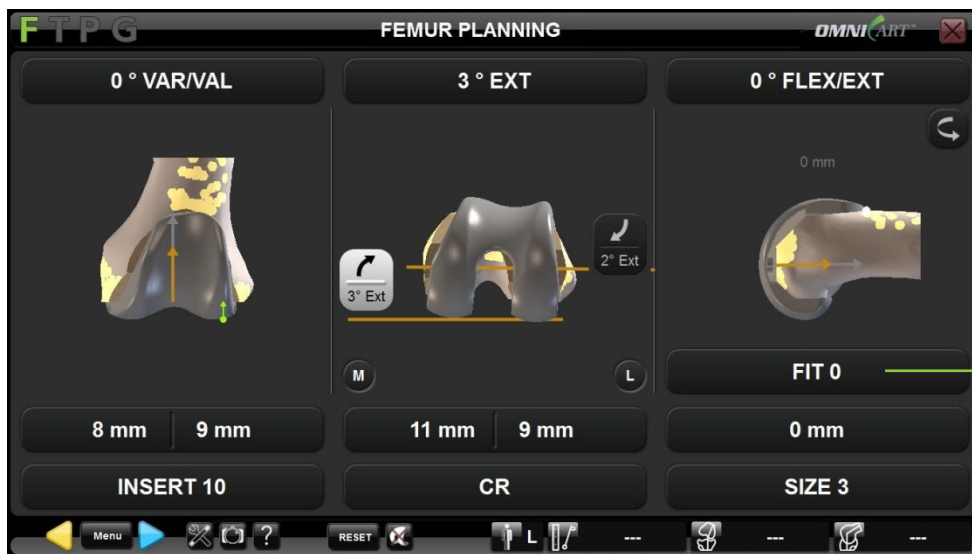

Check/Adjust Femur
Component Fit

Femoral Component Fit adjustment during Distal Cut Navigation: Touch fit parameter button then touch +/-

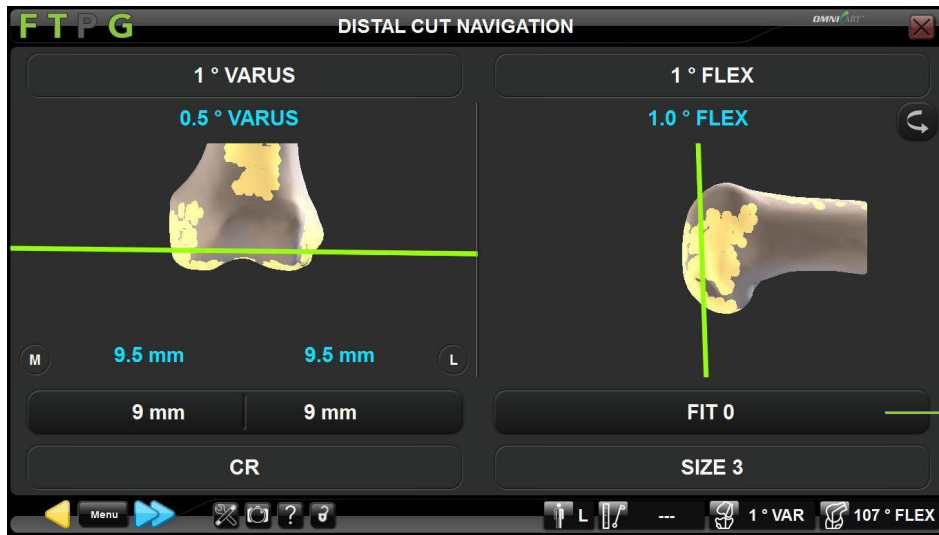

Check/Adjust Femur
Component Fit

Femoral Component Fit adjustment during Anterior Cut Navigation: Touch fit parameter button then touch +/-

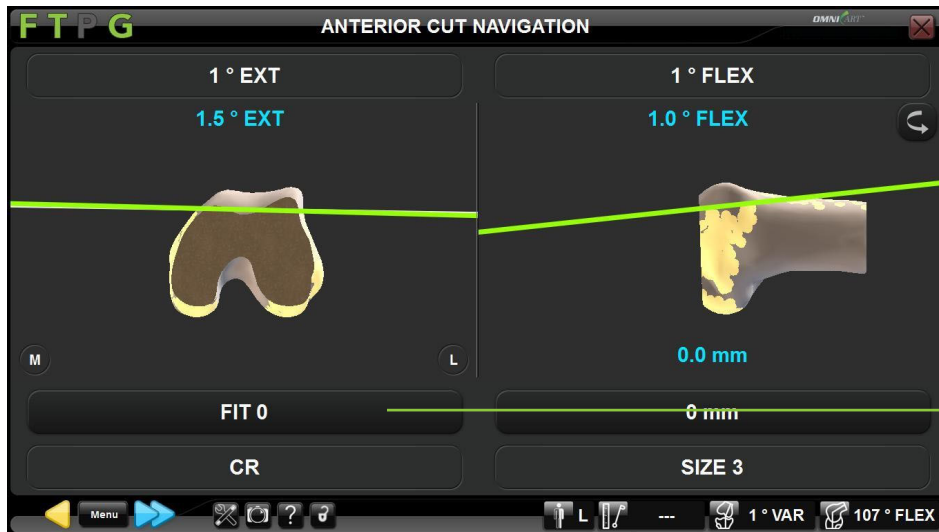

Check/Adjust Femur
Component Fit

Femoral Component Fit adjustment during Posterior Cut Navigation: Touch fit parameter button then touch +/-



Check/Adjust Femur
Component Fit

Notes: Fit adjustment can impact posterior resection and anterior notching values as resections positions will be slightly adjusted but position of the femoral component won't be modified.

If the fit adjustment value is decreased (e.g. from -0.25mm to -0.5mm) after the anterior or posterior cuts have already been performed, the value is displayed in red indicating the prior resection removed the bone.



WARNING: The femoral component fit adjustment (-0.25mm, -0.50mm, -0.75mm) accuracy may not be maintained if the OMNIBot is recalibrated after the anterior or posterior resection has been made.

4.12 Femoral Planning with Predictive Balance™

The BalanceBot is a tensioning instrument with integrated force sensors and position actuators. Coupled with navigation it assists the surgeon with ligament balancing during total knee arthroplasty.

Note: Select a tibia cut 1st profile with Initial Balance Assessment with the BalanceBot (see §5.2).



WARNING: The device is intended to function at room temperature. If the device is too warm, you must wait for it to cool down to room temperature.

Prepare the BalanceBot:



Select the correct markings Tibial Plate size and side (#NS-5011L to NS-5016R) and attach it to the BalanceBot (#NS-52000/NS-52900) with a H3.5 screwdriver (#KS-62030).

Note: the tibial cut or resected tibial plateau can be used to determine the appropriate Tibial Plate size.



Select the correct pair (A+B) of Femoral Paddles size and side (#NS-5022L-A to NS-5022L-B) and attach them to each one of the two axes of the BalanceBot (#NS-52000/NS-52900) with a H3.5 screwdriver (#KS-62030). Paddle A goes with Axis A and Paddle B goes with Axis B.



WARNING: If Tibial Plate or any of the two Femoral Paddles appear to be not correctly tightened after the BalanceBot calibration has been completed, then they must be tightened correctly, and the BalanceBot calibration step must be performed again using Menu.

Connect the BalanceBot to the Station:



Connect one end of the sterile Spacer Cable (#NS-44000) to the BalanceBot (#NS-52000/NS-52900). The red dot on the cable connector should align with the red dot on the spacer connector or with the anterior face of the BalanceBot.

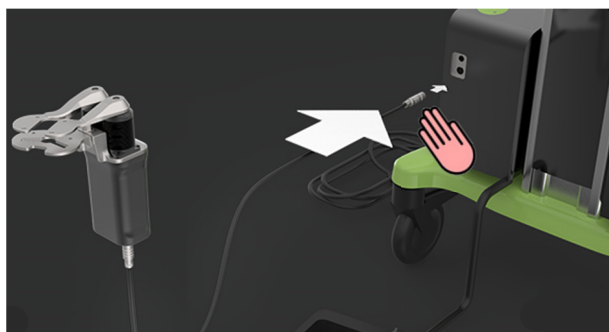





Keep the BalanceBot and most of the connecting cable on the operating table and hand off the other end of the cable to the non-sterile personnel to connect it to the corresponding BalanceBot connector (left connector) on the OMNIBotics Station. The red dot on the connector should align with the red dot on the connector port of the Station.



WARNING: To avoid damage to connectors the grey BalanceBot cable must be connected to the indicated Spacer connector port of the Station Enclosure Box and not to the OMNIBot™ connector port with the green ID ring.



WARNING: When installing the BalanceBot leave some extra length of cable near the patient. The cable should be coiled in a loop of at least 30 cm (12 inches) in diameter and placed beside the patient. In case the cable is accidentally pulled this loop will help prevent

	the cable from being disconnected or damage to the spacer, cable, or a delay in surgery. If the BalanceBot is disconnected after calibration, the spacer must be recalibrated.
	WARNING: The BalanceBot Cable linking the spacer to the Station enclosure must be treated with care and protected from mechanical damage. Do not kink or crush the cable by running over it with heavy equipment on the floor.
	WARNING: Always have one spare BalanceBot Cable to replace an out of order cable.
	WARNING: Try to avoid direct contact of the BalanceBot Cable and the patient's tissue or bone.
	WARNING: In the event that BalanceBot fails to connect, the surgeon can continue the navigation protocol using the standard spacer blocks or trial insert for ligament balance.



Calibrating the BalanceBot:

- Hold the BalanceBot body vertically in one's hand. Make sure that the Tibial Plate and Femoral Paddles are tightly locked to the spacer body.



Note: The BalanceBot must be taken out of the knee joint, the Tibial Plate / Femoral Paddles must be tightly locked, and no external force must be applied to the BalanceBot during the entire process to guarantee accuracy each time the BalanceBot is calibrated.

- Touch  and hold it down throughout the entire calibration process of the BalanceBot. The acquisition will complete when the green bar fills up and the spacer will both retract and expand completely.

	WARNING: Before calibrating the BalanceBot make sure nothing can interfere with device movement especially when spacer will retract to its lowest position. If this is not the case the accuracy of the system could be affected.
	WARNING: Do not place hands or fingers on Tibial Plate or Femoral Paddles during the calibration process to prevent getting pinched.
	RECOMMENDATION: If the BalanceBot is disconnected (i.e. emergency stop button pressed, or cable disconnected) after the calibration has been completed, the BalanceBot will need to be recalibrated.

Assess initial ligament balance throughout flexion/extension with the BalanceBot in Force Control Mode:

Note: The steps described below are immediately following Tibial Cut Navigation.

The screenshot shows the 'INITIAL BALANCE ASSESSMENT' screen for the FT PG system. It features two knee joint diagrams: one for '1° VARUS' and one for '5° FLEX'. The '1° VARUS' diagram shows medial and lateral forces of 80 N and gaps of 11.5 mm and 12.0 mm respectively. The '5° FLEX' diagram shows a knee in a flexed position. A graph on the right plots 'Actual Gaps [mm]' against knee flexion angles from -10° to 130°. The graph shows data points for VARUS (15°), Leg Alignment (3°, 0°, 3°), and VALGUS (15°). A 'Clear' button is located below the graph. The bottom control bar includes buttons for 'Menu', navigation arrows, 'Engage/Release', 'Mode', 'Home', 'Lbs | N', and '1° VAR' / '5° FLEX' selection buttons.

Control real time Medial Force & Gap

Control current Varus/Valgus of the leg in extension and Internal/External (Axial) Rotation in flexion

Control real time Lateral Force & Gap

Control current Flexion/Extension of the leg

Clear graphs

Toggle forces display between Pounds and Newtons

Retract the BalanceBot to lowest position (Home)

Switch the BalanceBot from Force Control Mode to Height Control Mode

Set target force in Flexion

Engage/Release the BalanceBot

Set target force in Extension

- After Tibial Cut Validation, place the leg in full extension and insert the BalanceBot into the knee joint.
- Set target force in extension (default 80N at 0°) and in flexion (default 80N at 90°). Adjust force as desired to preferred tension.

Note: The BalanceBot will apply the same force to both medial and lateral compartments and will automatically adjust the force applied to the level of flexion if different forces are targeted for extension and flexion.

- Ensure the ankle is free to move mediolaterally when acquiring gap in extension
- Touch  to engage the BalanceBot and to apply the target forces to each compartment of the knee joint.

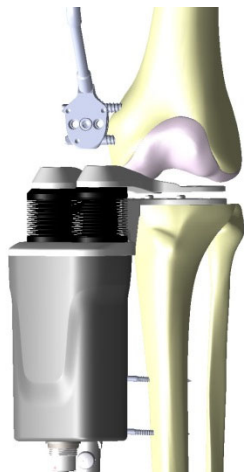

- With the knee in extension, check the knee gaps and the leg alignment in both the frontal, sagittal and axial planes.
- If the surgeon desires to create a surgical plan at this step to correct for tibiofemoral malalignment, ligament releases may be performed under constant force in extension.

Note: If possible, keep the BalanceBot engaged into the knee joint and observe the change in leg alignment as a result of releases performed.

Note: Use of a needle puncture technique is recommended for better control during the ligament release process. Care should be taken not to over-release any ligaments.

Once satisfied with knee gaps and leg alignment in extension, the gaps can be acquired dynamically throughout flexion by slowly flexing the leg from full extension to maximum flexion. Support the femur from the back of the knee during the acquisition to minimize the influence of the weight of the femur on the gap measurements.

Note: One might want to clear the plotted graph on the right side of the screen before registering the final gaps curves. To do so touch the “Clear” button.

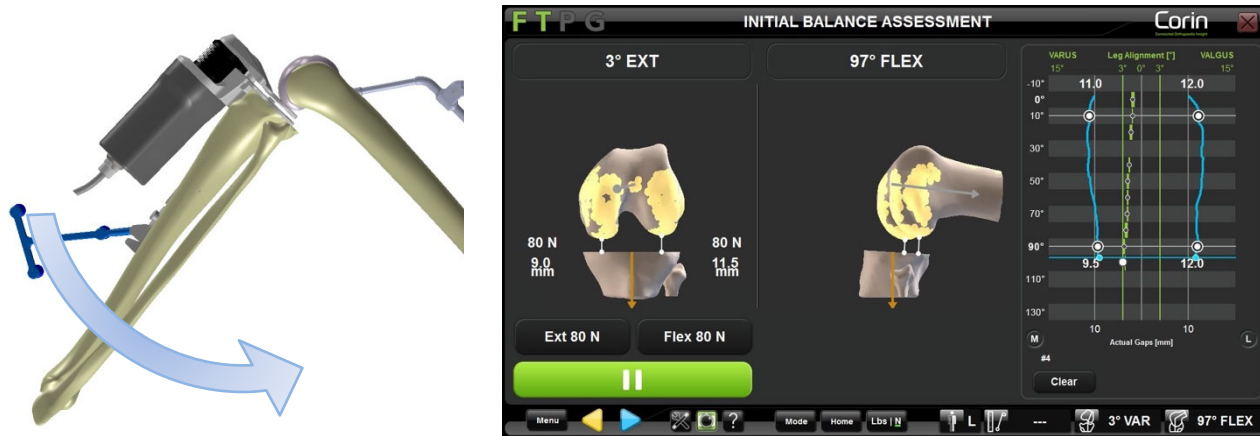

Note: Control the rotation of the tibia relative to the femur during the acquisition.

- With the knee in flexion, check the knee gaps and the axial rotation of the femur.

Note: Axial rotation of the femur is computed as the angle between the Femur Primary Rotation reference (Posterior Condyles) and the Tibial Mechanical Axis. It indicates the femoral implant rotation required to create a rectangular joint space in flexion when the tibia is cut neutral to the mechanical axis.

- If the surgeon desires to create a surgical plan at this step to correct for tibiofemoral malalignment, ligament releases may be performed under constant force in flexion.

Note: If possible, keep the BalanceBot engaged into the knee joint and observe the change in leg alignment as a result of releases performed.

- Check the final gaps and the leg alignment throughout the range of motion using the graph on the right side of the screen. Gap acquisitions at 0° and 90° of flexion are required at a minimum to proceed to the next step.

- Touch  and remove the BalanceBot from the knee joint.

Note: The BalanceBot will automatically retract to its lowest position once the  has been touched.

Tip: If the knee cannot reach full extension with the BalanceBot positioned in the knee joint, consider one or more of the following options: ensure the back of the knee has been sufficiently cleared of the meniscus and other soft tissues; gently push down on anterior aspect of the knee to bring the knee joint into full extension; perform a provisional resection of the distal femur. For a tight knee in extension, consider resecting one to two more millimeters of femur distally when planning the femoral implant.

Adjust Femoral Planning:

The initial proposed size and position of the femoral implant is based on the previously generated OMNIBotics Bone Morphing™ model and specifics of the implant used. Predictive gap values are shown in extension and in 90° of flexion. Predictive implant gaps are plotted throughout the range of flexion according to the pre-resection gaps acquired with the BalanceBot and the current planned position of the femoral implant. Predictive Leg Alignment based on the validated tibial and planned femoral bone cuts is also displayed.

1° VARUS

3° EXT POST. CONDYLES

ANT Cut Depth: 0 mm

11.5 mm

11.5 mm

9.0 mm 9.0 mm

SIZE 2+

11.5 mm

11.5 mm

12.5 mm 10.5 mm

0° FLEX/EXT

INSERT 11

VARUS 15° 3° 0° 3° 15° VALGUS

Leg Alignment [°]

10°

11.5

11.5

11

0

11

Predictive Gaps [mm]

Control predictive Lateral gap in flexion

Control predictive Medial gap in flexion

Control predictive Lateral gap in extension

Control predictive Medial gap in extension

Set preferred balancing angle in Extension from 0° to 15° Flexion

Check Predictive Gaps curves and Predictive Leg Alignment

Show sagittal view of the femur

Note: The relative positions of the femur and tibia displayed on the screen in extension and flexion correspond to the relative joint positions recorded during the initial balance assessment. These positions should correspond to stable and correctly aligned positions of the knee as controlled with the BalanceBot.

The mediolateral gaps displayed on screen will not be equal in most cases, so it may be necessary to adjust the plan to achieve equal spaces in extension and in flexion. This is required in order to obtain the same stability with the final implant as what has been assessed during ligament balancing with the BalanceBot.

Note: The ‘AutoBalance’ function can be used to automatically suggest an initial femoral plan that attempts to achieve equal extension and flexion gaps. When the feature is activated (See §5.3), use the AUTO button on the screen to toggle between the proposed planning optimization and the default “Measured Resections” plan in order to assess the proposed changes to the plan.

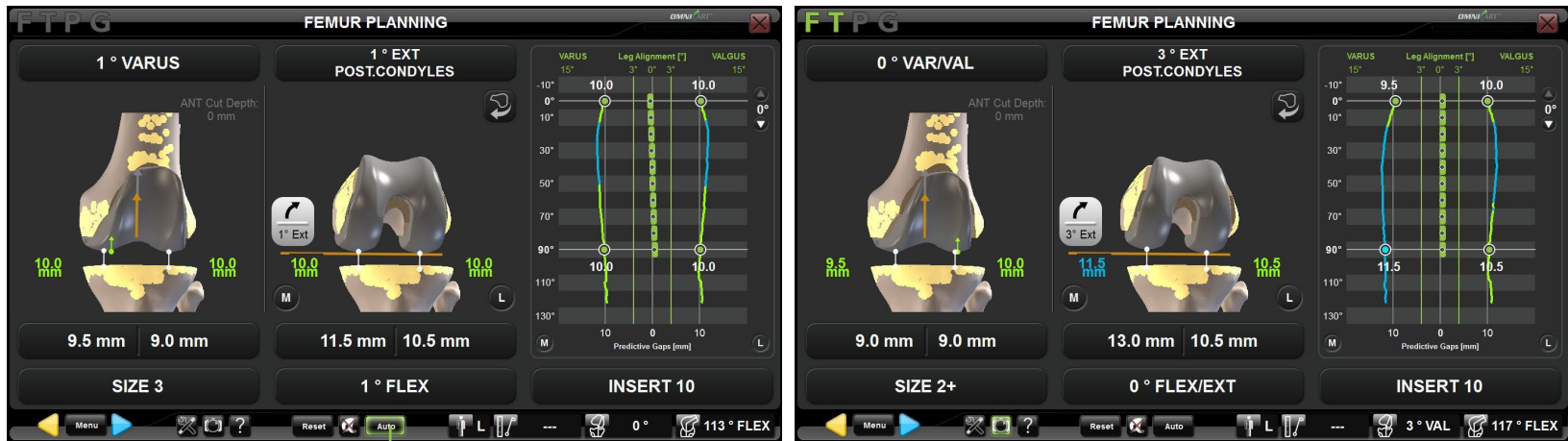

Toggle between “AutoBalance” and “Measured Resection” plan

Optimized “AutoBalance” planning

Default “Measured Resection” planning

- Visualize the proposed femoral plan on the bone model and assess bone resection values and predictive gaps.

Note: Predictive gaps are displayed with a color code to indicate the difference between the computed predictive gap and the planned tibial implant thickness.

Color	“Gap – Implant Thickness” [mm]
Red	<-1
Green	-1 to 1
Light Blue	>1

- Adjust femoral planning parameters (position, size) according to surgical judgment.
- Observe change in gap values and curves.

Note: Touch the predictive gap graph anywhere between extension and 90° flexion to display a scan line indicating the amount of gap opening between the predicted gap curves and the selected tibial insert in that flexion position of the leg.

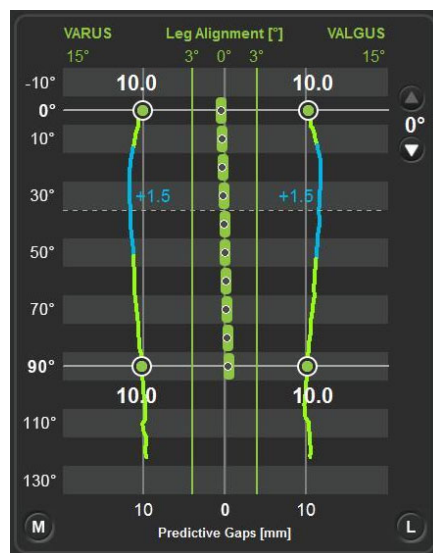

- Touch  to confirm the Femoral Implant Plan

4.13 Tibial Cut navigation with the Blade Guide

The Blade Guide (#4160-5000) has been specifically designed for the navigation and localization of standard cutting blocks.



WARNING: Before the navigation of the tibial cut, it is strongly recommended to verify that the “T” reference has not moved by placing the Pointer on the bone surface.
If the displayed distance (See §2.9) from the Pointer to the bone is more than 1mm in reliable areas of the reconstructed bone model, the references have certainly moved. Accuracy is no longer guaranteed and the Tibia should be re-registered (Axis and Bone Morphing) or the user should revert to a conventional surgical protocol.
When using single point registration on the tibia, the pointer should be placed on the tibial confidence point in order to check registration accuracy.

Navigating the Tibial Cut Block (#WS-20002 & WS-20003):

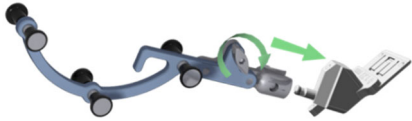

Use the push button to attach the “G” reference (#0501-5070 or NS-300G4) to the Blade guide (#4160-5000).



Insert the Blade Guide equipped with the “G” reference into the cutting slot of the tibial cut block from the manual instrument set.

The bottom face of the Blade Guide should be in full contact with the face of the cut block that guides the saw blade.

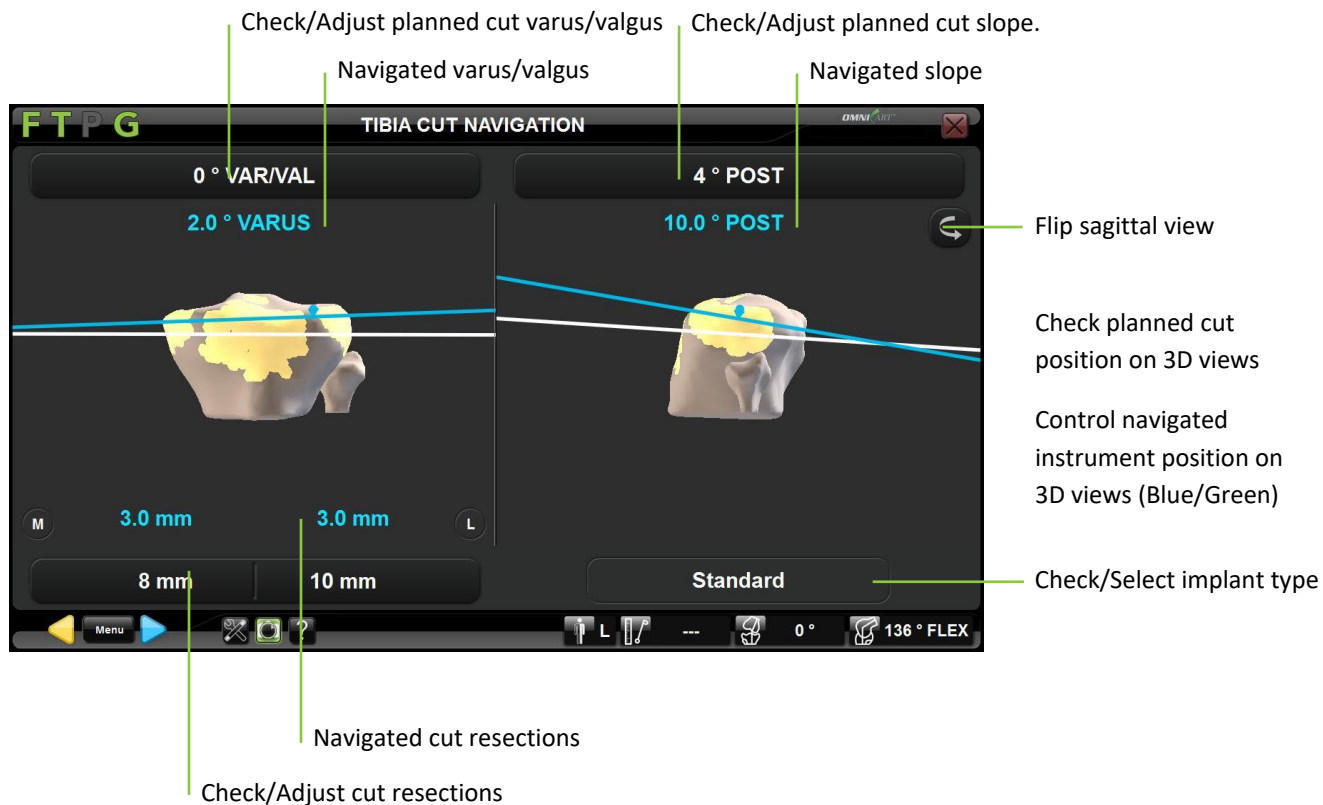

Select implant type – Apex Knee only: If needed and when using the Tibia Single Point Registration option (no Tibia Planning), then touch the “Standard” button then touch \langle / \rangle to change the implant type to “Modular”.

Note: Selecting the Modular tibia implant for Apex Knee will automatically default the Tibial Slope to 0° and the Tibial Resection to +2mm.

Adjust the planned cut position: Touch parameter button to be adjusted then touch +/-.

Note: When using single point registration on the tibia, the 3D model of the tibia is not representative of the true patient anatomy. As a consequence, the planned cut position on 3D views won’t necessarily be representative neither. In this case it is important to mainly adjust cut position based on displayed numbers for each parameters which are accurate in any case.

Navigating instrument position to the planned cut position: Manually adjust the position of the tibial cut block equipped with the Blade Guide and the “G” reference until the cutting lines are aligned and green (Blue lines indicate that the Cut Block is not perfectly aligned with the planning).

Performing the Tibial Cut:

- Pin the tibial cut clock with the pins provided with the manual instrumentation.
- Touch  to record the position of the cut block and remove the Blade Guide from the cut block slot.



WARNING: Verify that the cutting block is secure before performing the bone cut.

4.14 Tibial Cut navigation with the NanoBlock™

The NanoBlock (#4137-5000) is a cutting block that has been specifically designed for the navigation of tibial and femoral distal cuts. It allows fine adjustment of the orientation and depth of the cut.



WARNING: Before the navigation of the tibial cut, it is strongly recommended to check that the “T” reference has not moved by placing the Pointer on the bone surface.

If the displayed distance (See §2.9) from the Pointer to the bone is more than 1.0mm in reliable areas of the reconstructed bone model, the references have certainly moved. Accuracy is no longer guaranteed and the Tibia should be re-registered (Axis and Bone Morphing) or the user should revert to a conventional surgical protocol.

When using single point registration on the tibia, the pointer should be placed on the tibial confidence point in order to check registration accuracy.

Navigating the NanoBlock (#4137-5000):

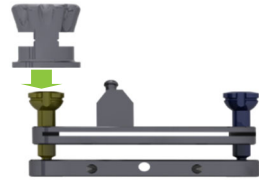

Adjust the initial position of each NanoBlock (#4137-5000) adjustment screw using the NanoBlock Initialization Socket (#4137-2050).

The machined groove on the head of each screw should appear in the center of the window and line up with the machined grooves on the initialization socket.

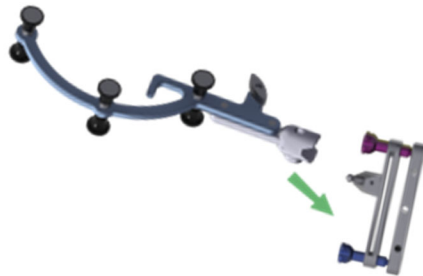
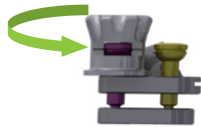

Use the push button to attach the “G” reference (#0501-5070 or NS-300G4) to the NanoBlock.

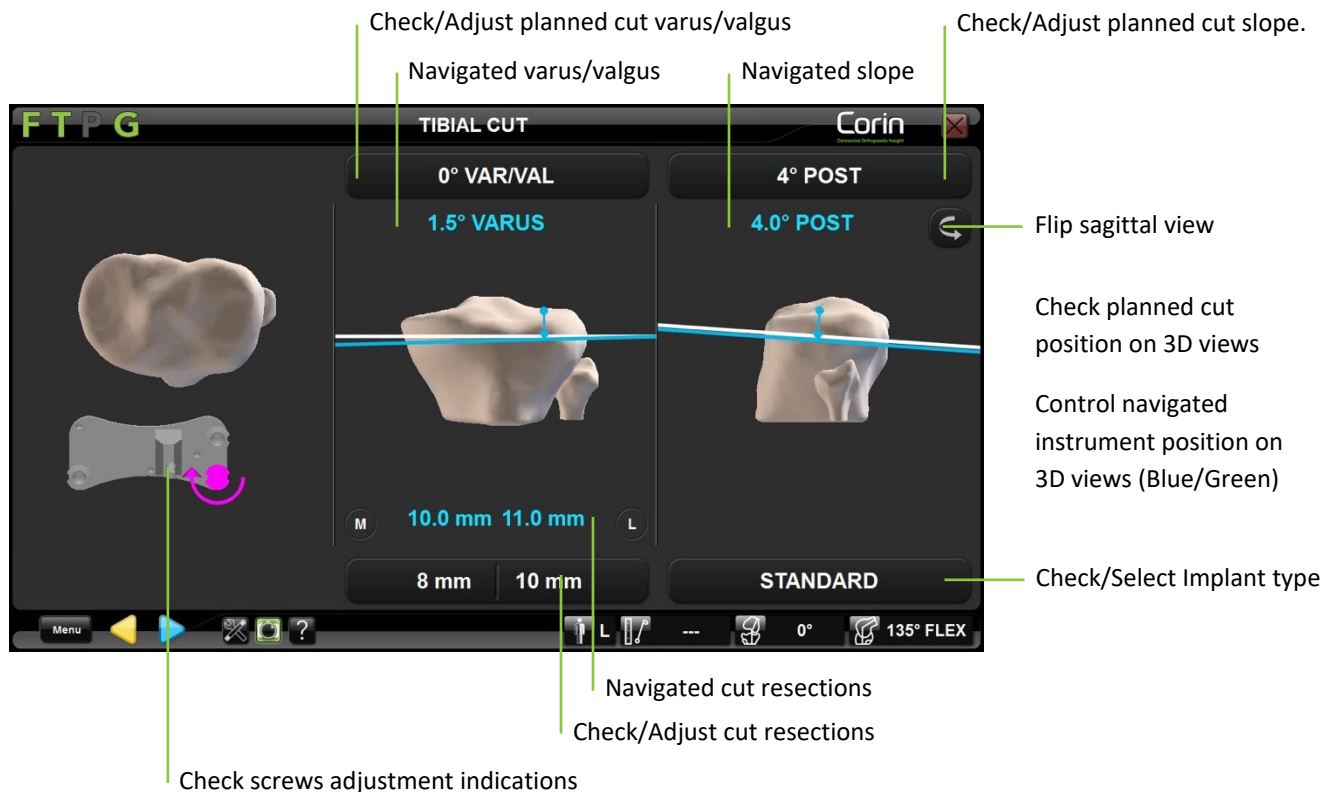

Select implant type – Apex Knee only: If needed and when using the Tibia Single Point Registration option (no Tibia Planning), then touch the “Standard” button then touch \langle / \rangle to change the implant type to “Modular”.

Note: Selecting the Modular tibia implant for Apex Knee will automatically default the Tibial Slope to 0° and the Tibial Resection to +2mm.

Adjust the planned Tibia cut position: Touch the parameter button to be adjusted then touch +/-.

Note: When using single point registration on the tibia, the 3D model of the tibia is not representative of the true patient anatomy. As a consequence, the planned cut position on 3D views won’t necessarily be representative neither. In this case it is important to mainly adjust cut position based on displayed numbers for each parameters which are accurate in any case.

Position the NanoBlock to the planned cut:

- Manually adjust the position of the NanoBlock equipped with the “G” reference until the cutting lines become blue or green on the screen.
Note: Red cutting lines indicate that the NanoBlock is too far from the target line and cannot be pinned in this position.

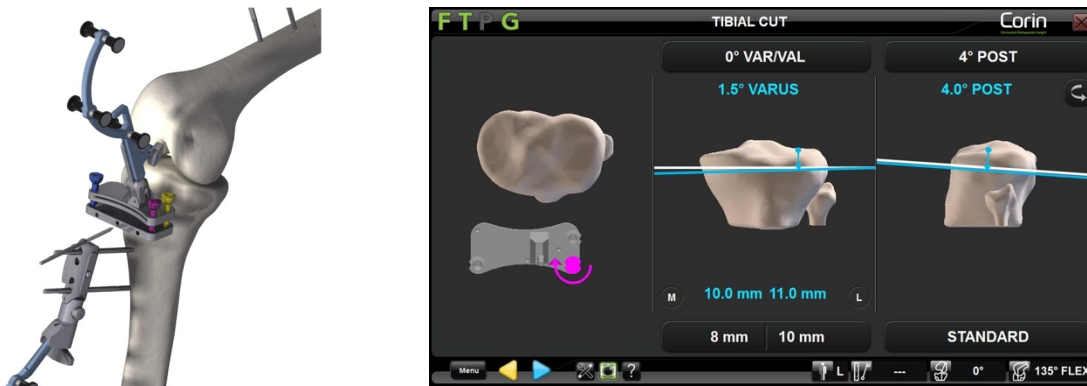

- When the cutting line is blue or green attach the NanoBlock to the tibia with 2 or 3 Ø3.2mm Bone Screws (#4148-1004 or #4148-1005). Start with the center hole as this eases adjustability by providing a hinge point. The two outer holes are converging.



WARNING: The use of third party pins or screws can cause serious damage to the NanoBlock and serious harm to the patient.

- Adjust each of the 3 NanoBlock screws using the H3.5 Screwdriver (#KS-62030) following the directions on the screen. In the example below, the blue screw needs to be turned clockwise.

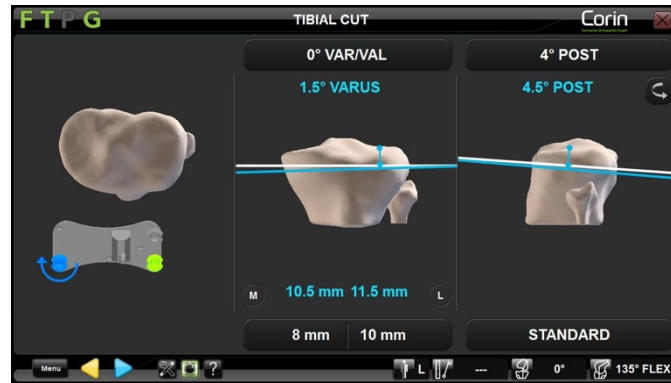
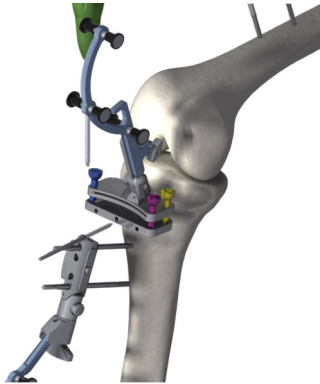



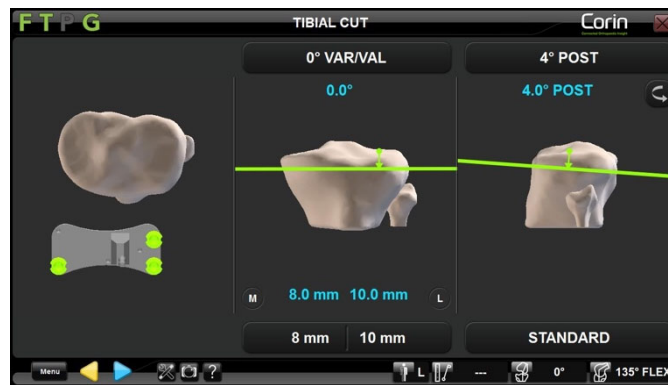
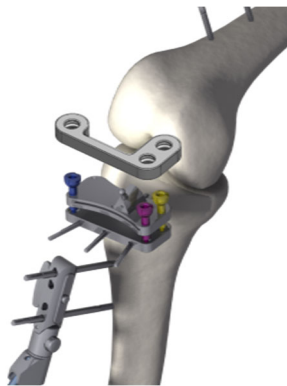

WARNING: When adjusting the position of the NanoBlock cutting plane with the H3.5 Screwdriver do not over-torque the screws as this could cause damage to the screws and compromise stability of the NanoBlock.

Perform the Tibial Cut: The planned cut position has been reached when all 3 screws turn green.

- Place the NanoBlock Screw Head Stabilizer (#4137-5050) onto all 3 screws.



- Touch  to record the position of the NanoBlock and remove the “G” from the NanoBlock using the push-button on the reproducible fixation.
- Cut the bone using an oscillating saw blade of 0.049” or 1.27 mm which corresponds to the thickness of the slot to reach a precise cut.

	WARNING: Only use 1.27mm blades with the NanoBlock.
	WARNING: Check that the cutting block is secure before performing the bone cut.
	WARNING: The heat caused by the saw blade in an OMNI cutting block is identical to a standard cutting block. In case of overheating, spray the block with water.

4.15 Femoral Distal Cut navigation with the NanoBlock™

The NanoBlock (#4137-5000) is a cutting block that has been specifically designed for the navigation of tibial and femoral distal cuts. It allows fine adjustment of the orientation and height of the cut.



WARNING: Before the navigation of femoral cuts, it is strongly recommended to check that the F reference has not moved by placing the Pointer on the bone surface.

If the displayed distance (See §2.9) from the Pointer to the bone is more than 1mm in reliable areas of the reconstructed bone model, the references have certainly moved. Accuracy is no longer guaranteed and the Femur should be re-registered (Axis and Bone Morphing) or user should revert to a conventional surgical protocol.

Navigating the NanoBlock (#4137-5000):

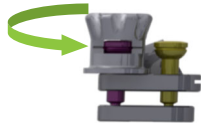
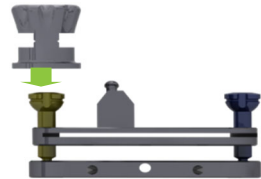

Adjust the initial position of each NanoBlock (#4137-5000) adjustment screw using the NanoBlock Initialization Socket (#4137-2050).

The machined groove on the head of each screw should appear in the center of the window and line up with the machined grooves on the initialization socket.

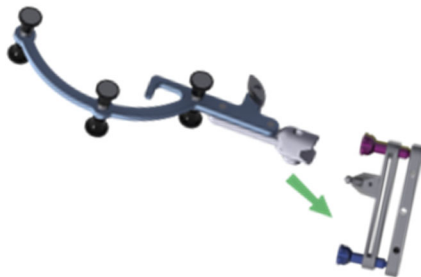

Use the push button to attach the “G” reference (#0501-5070 or NS-300G4) to the NanoBlock.

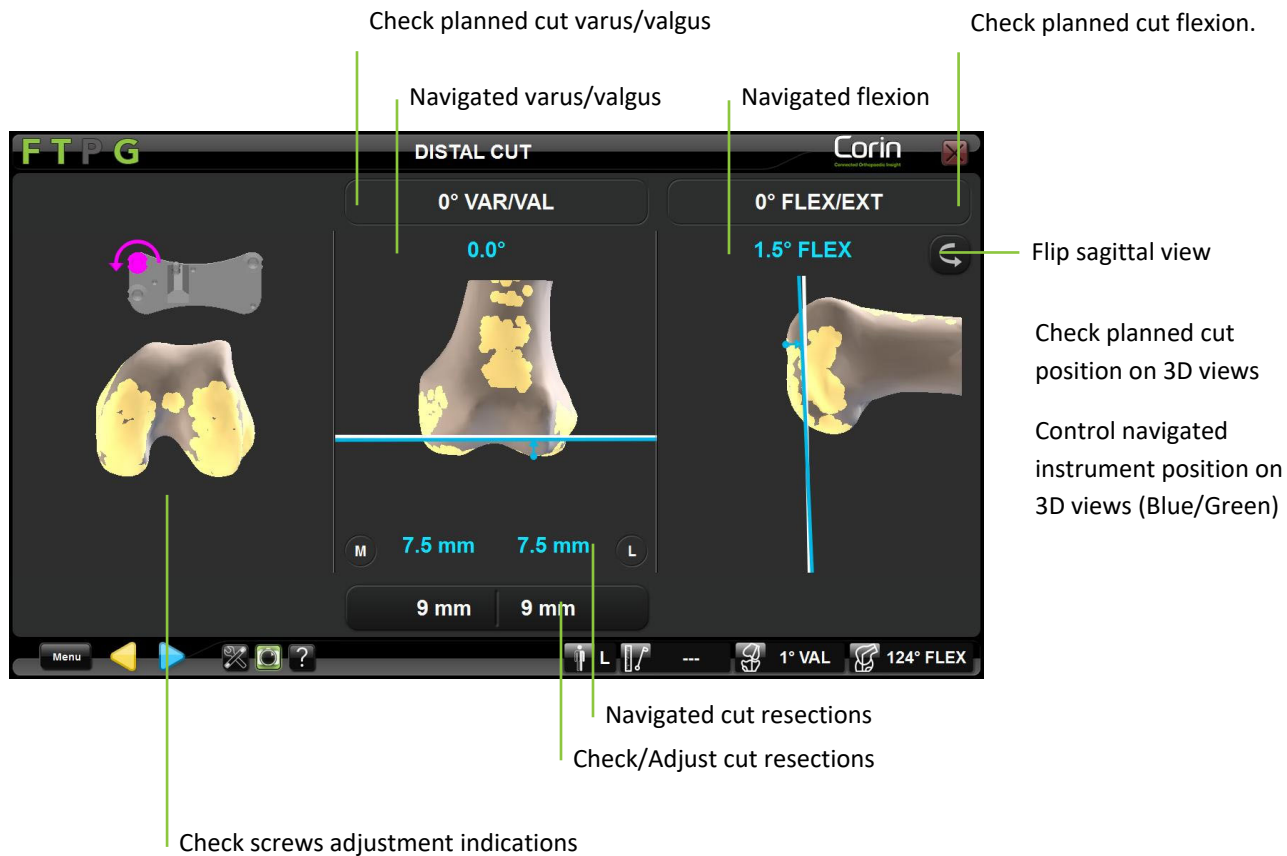

Adjust the planned distal resection: Touch parameter button to be adjusted then touch +/-.

Position the NanoBlock to the planned Distal Cut:

- Manually adjust the position of the NanoBlock equipped with the “G” reference until the cutting lines turn blue or green on the screen.
Note: Red cutting lines indicate that the NanoBlock is too far from the planned cut and should not be pinned in this position.

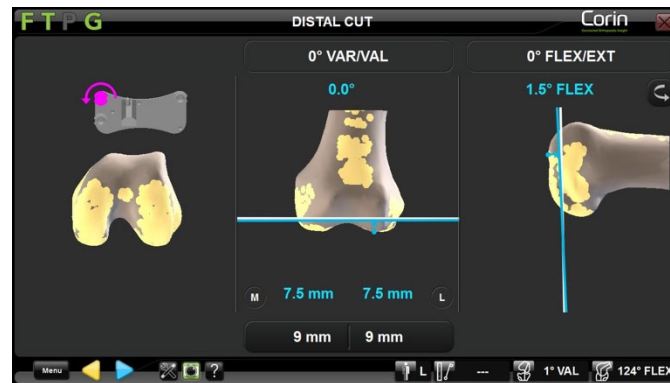
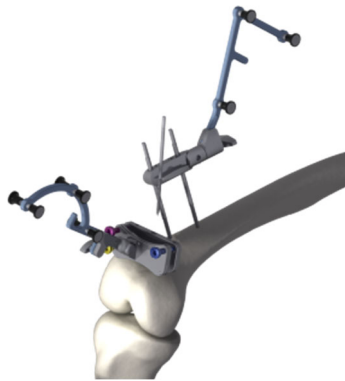

- When the cutting line is blue or green attach the NanoBlock to the femur with 2 or 3 Ø3.2mm Bone Screws (#4148-1004 or #4148-1005). Start with the center hole as this eases adjustability by providing a hinge point. The two outer holes are converging.



WARNING: The use of third party pins or screws can cause serious damage to the NanoBlock and serious harm to the patient.

- Adjust each of the 3 NanoBlock screws using the H3.5 Screwdriver (#KS-62030) following the directions on the screen. In the example below, the blue screw needs to be turned clockwise.

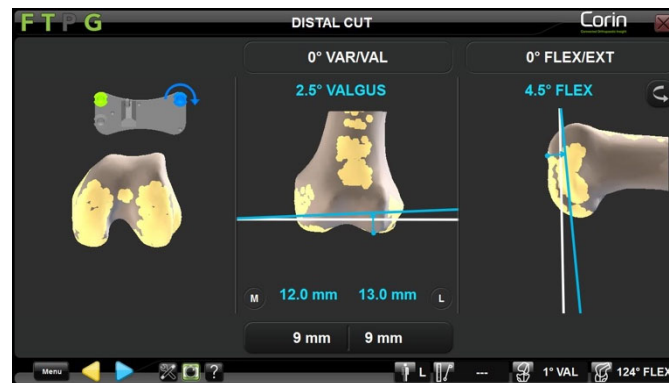
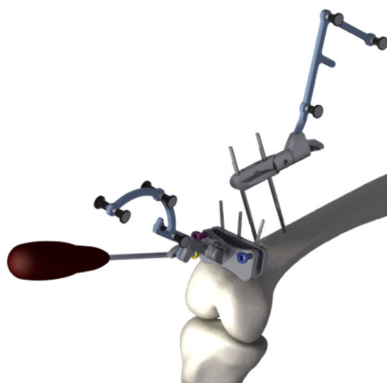





WARNING: When adjusting the position of the NanoBlock cutting plane with the H3.5 Screwdriver do not over-torque the screws as this could damage the screws and compromise stability of the NanoBlock.

Perform the Femoral Distal Cut: The planned cut position has been reached once all the screws are green.

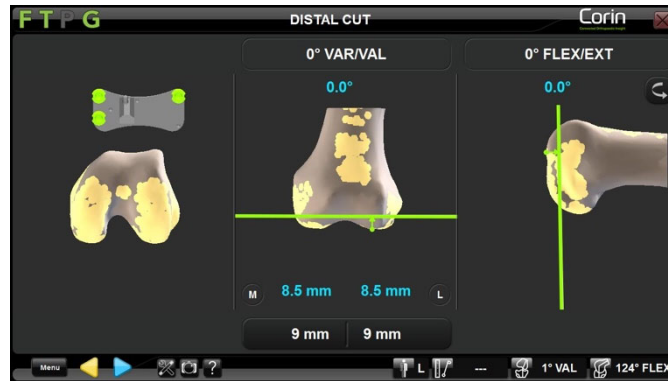
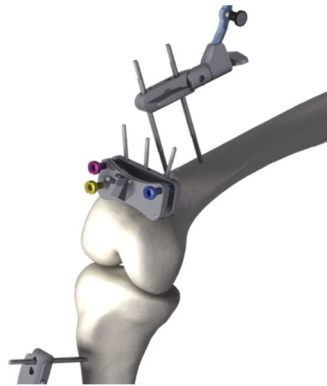
- Place the NanoBlock Screw Head Stabilizer (#4137-5050) onto all 3 screws.



- Touch  to record the position of the NanoBlock and remove the “G” from the NanoBlock using the push-button on the reproducible fixation.
- Cut the bone using an oscillating saw blade of 0.049” or 1.27 mm which conforms to the thickness of the slot to reach a precise cut.



WARNING: Only use 1.27mm blades with NanoBlock.



WARNING: Check that the cutting block is secure before performing the bone cut.



WARNING: The heat caused by the saw blade in an OMNI cutting block is identical to a standard cutting block. In case of overheating, spray the block with water.

4.16 Femoral AP Cut navigation with the Validation Plate



WARNING: Before the navigation of femoral cuts, it is strongly recommended to check that the F reference has not moved by placing the Pointer on the bone surface.

If the displayed distance (See §2.9) from the Pointer to the bone is more than 1.0mm in reliable areas of the reconstructed bone model, the references have certainly moved. Accuracy is no longer guaranteed and the Femur should be re-registered (Axis and Bone Morphing) or user should revert to a conventional surgical protocol.

Navigating the Validation Plate:



Use the push button to attach the “G” reference (#0501-5070 or NS-3000G) to the Validation Plate (#4161-5400, NS-40500 or NS-54035 for Apex Knee and #NS-54035 for Unity Knee).

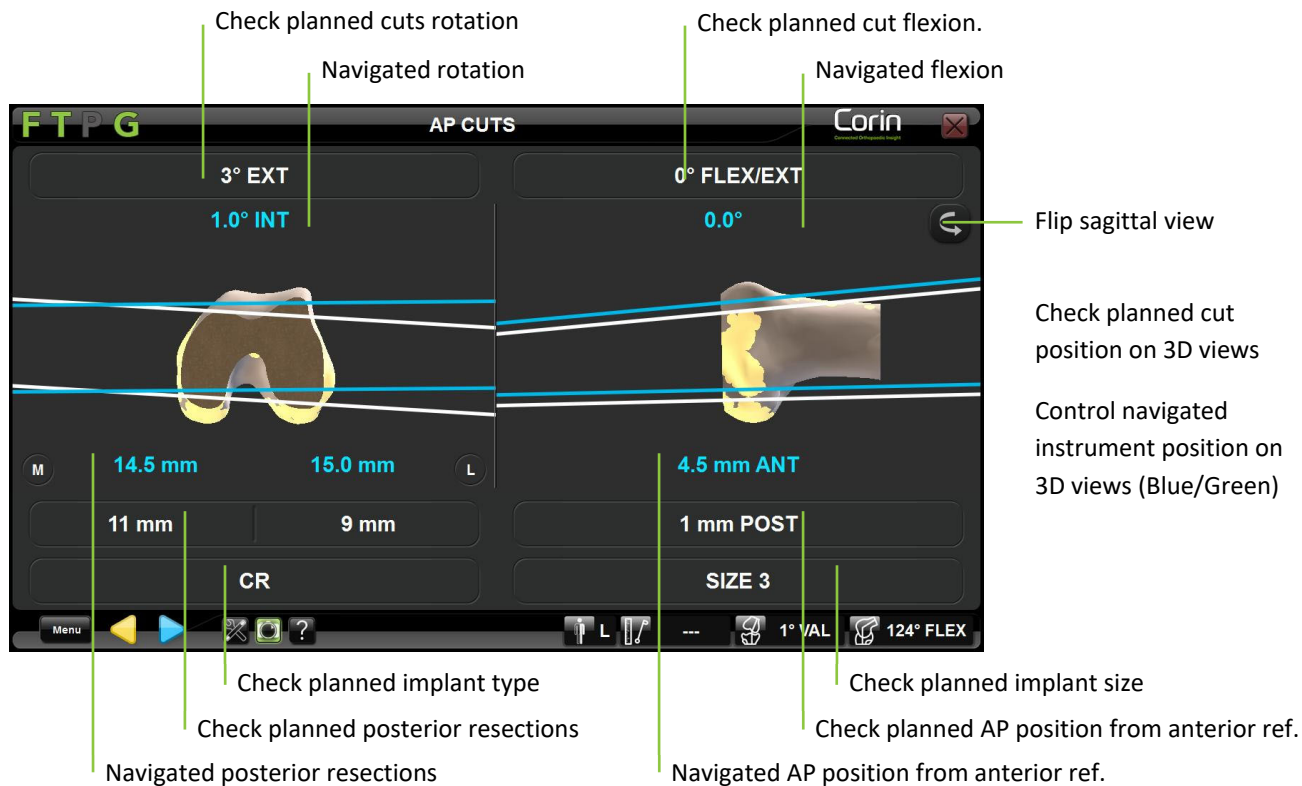

Adjusting the Validation Plate to the planned cuts:

- Place the Validation Plate equipped with the “G” reference flat on the distal cut and manually adjust the guide to align the cut line with the target line on the screen.

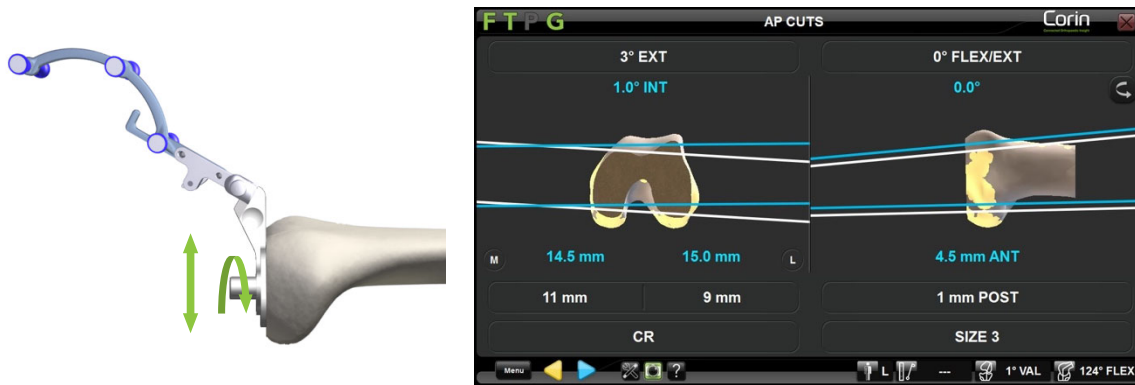

- Once the guide position matches the planned position, drill the two pilot holes through the appropriate guides of the Validation Plate using a stop drill provided with the manual instrument set – See marking on the Validation Plate.

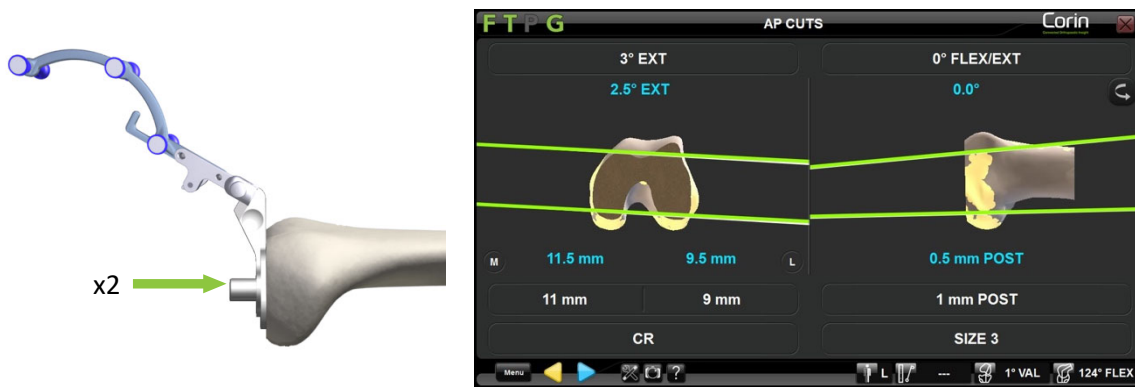

WARNING: The validation plate and or the drilling guides are specific to each implant (Apex Knee or Unity Knee). Make sure that you are using the appropriate plate and guides for the used implant before navigating Femoral AP cuts or the obtained position of the 4 in 1 cutting block could be incorrect.



RECOMMENDATION: Leave a drill bit or a pin in the first hole while drilling the second hole in order to help stabilize the Validation Plate during the drilling process.

Perform the Femoral AP Cuts: Once all the screws are green the final position is reached,

- Touch  to record the position of the Validation Plate and remove it from the bone.
- Place the appropriate size 4 in1 femoral resection block provided with the manual instrument set for the used implant on the distal femur by driving the block pins into the previously drilled holes.
- Cut the bone using an oscillating saw blade of 0.049" or 1.27 mm which conforms to the thickness of the slot to reach a precise cut.

4.17 Femoral Cuts navigation with the OMNIBot™

The OMNIBot system is a motorized cutting block that is directly attached to the patient's femur. Coupled with navigation, it ensures the precision of the cuts by determining the exact position of the cutting guide for each of the 5 planned femoral cuts.

Prepare the OMNIBot motor: The assembly of the non-sterile OMNIBot Motor Unit (#4144-6000) into the OMNIBot Sterile Enclosure (#4144-7000 & 4144-4000 or NS-41000 & NS-42000) should be conducted under aseptic conditions.

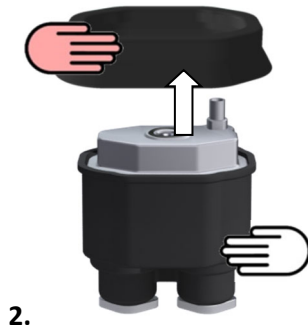
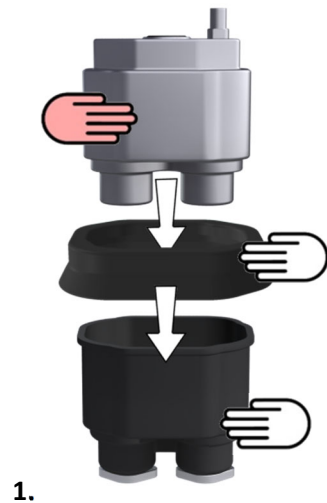

To ensure sterility, the OMNIBot motor unit must be properly placed in the sterile enclosure. This requires the assistance of two people, one sterile and one non-sterile:

1. Place the OMNIBot Insertion Guide (#4144-8000) on the OMNIBot Enclosure Body (#4144-7000 or NS-41000) and drop the non-sterile OMNIBot Motor Unit (#4144-6000) in the OMNIBot Enclosure Body.

Note: The OMNIBot Enclosure body and OMNIBot Insertion Guide are designed to prevent any contact between the non-sterile OMNIBot Motor Unit and the outside of the OMNIBot Enclosure.

2. Remove the OMNIBot Insertion Guide which is no longer sterile.

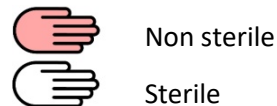

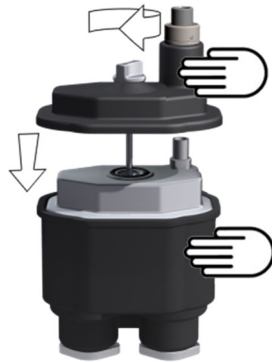

3.

3. Close the OMNIBot Enclosure Body with the OMNIBot Enclosure Cover (#4144-4000 or NS-42000) and lock it securely with the screw.

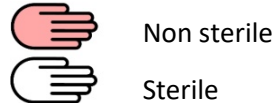

	<p>WARNING: The protocol for inserting the OMNIBot Motor Unit into the OMNIBot Enclosure is designed to prevent contamination of the external surface the OMNIBot Enclosure. This protocol requires the use of the OMNIBot Insertion Guide and must be strictly followed. Do not insert the OMNIBot Motor Unit into the OMNIBot Enclosure Body without the OMNIBot Insertion Guide. Do not use the OMNIBot if the OMNIBot Insertion Guide is damaged or deformed.</p>
	<p>WARNING: Before using the OMNIBot, verify that the OMNIBot Enclosure Cover is completely closed and sealed. The entire length of the perimeter of the OMNIBot Enclosure Cover must be in complete contact with OMNIBot Enclosure Body.</p>
	<p>WARNING: The OMNIBot Motor Unit is not sterile; it represents a potential source of infection for the patient. Never open the OMNIBot Enclosure during surgery.</p>
	<p>WARNING: Do not assemble the OMNIBot Motor Unit and its enclosure if the insertion guide is damaged, cracked, deformed, or does not mount properly on the OMNIBot enclosure.</p>

If using Enclosure Body #4144-7000:



Tighten the central locking screws on both axes of the OMNIBot Enclosure Body (#4144-7000) with the H3.5 screwdriver (#KS-62030) until the axes begin to turn.



Attach the Orientation Adjustment Interface (#4145-2000) to the face of the dedicated axis (#1) with an H3.5 screwdriver.

Attach the Cutting Guide Fixation Interface (#4146-1000) to the face of the other axis (#2) with the H3.5 screwdriver.

If using Enclosure Body #NS-41000:

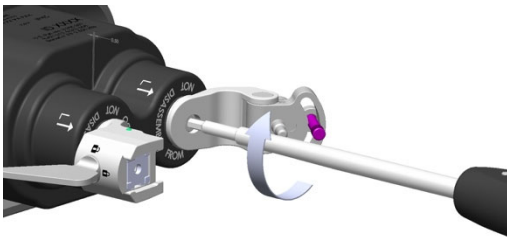

Tighten the central locking screws on both axes of the OMNIBot Enclosure Body (#NS-41000) with the H3.5 screwdriver until the axes begin to turn.



WARNING: If one of the axes of the OMNIBot Enclosure Body appears to be not correctly tightened after the OMNIBot calibration has been completed then it must be tightened correctly and both OMNIBot alignment and calibration steps must be performed again using Menu.

Connect the OMNIBot to the Station:

If using Enclosure Cover #4144-4000 and Cable #4144-5000:

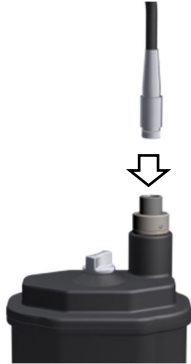

Connect the grey sleeve OMNIBot Cable (#4144-5000) connector to the OMNIBot Cover (#4144-4000). The red dot on the cable connector should align with the red dot on the cover connector.

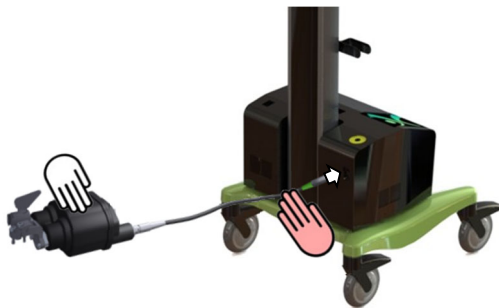

Keep the OMNIBot and most of the connecting cable on the operating table and hand off the green sleeve end of the cable to non-sterile personnel to connect it to the OMNIBot connector with the green ID ring on the OMNIBotics Station. The red dot on the connector should align with the red dot on the connector port of the Station.



WARNING: If using OMNIBot Cable #4144-5000, to avoid damage to connectors the green sleeve connector of the OMNIBot cable must be connected to the OMNIBotics Station Enclosure Box. The grey sleeve connector of the OMNIBot cable must be connected to the OMNIBot cover.

If using Enclosure Cover #NS-41000 and Symmetrical Cable #NS-43000:

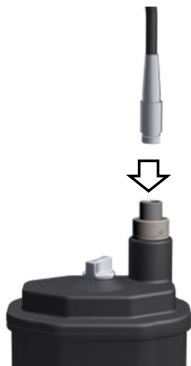

Connect any extremity of the OMNIBot Symmetrical Cable (#NS-43000) to the OMNIBot Cover (#NS-43000). The red dot on the cable connector should align with the red dot on the cover connector.



Keep the OMNIBot and most of the connecting cable on the operating table and hand off the other extremity of the cable to non-sterile personnel to connect it to the OMNIBot connector on the OMNIBotics Station. The red dot on the connector should align with the red dot on the connector port of the Station.

	WARNING: When installing the OMNIBot leave some extra length of cable near the patient. The cable should be coiled in a loop of at least 30 cm (12 inches) in diameter and placed beside the patient. In case the cable is accidentally pulled this loop will help prevent the cable from being disconnected or damage to the OMNIBot, cable, or potential harm to the patient. If the OMNIBot is disconnected after calibration, the OMNIBot must be recalibrated.
	WARNING: The OMNIBot Cable linking the OMNIBot Motor Unit to the Station enclosure must be treated with care and protected from mechanical damage. Do not kink or crush the cable by running over it with heavy equipment on the floor.
	WARNING: Always have one spare OMNIBot Cable to replace an out of order cable.



WARNING: Try to avoid direct contact of the OMNIBot Cable and the patient's tissue or bone.



WARNING: In the event that OMNIBot fails to connect, the surgeon can continue the navigation protocol using the NanoBlock™ by switching instrument option via the error message.

Navigating the OMNIBot Cutting Guide:

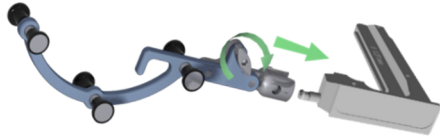

Use the push button to attach the “G” reference (#0501-5070 or NS-300G4) to an OMNIBot Saw Guide (#4146-5200, 4146-5300, XK-06449 or XK-06471).

Note: Before mounting the OMNIBot on the femur, make sure each axis is rotated according to which knee (right/left) is being operated on. For either side, align the “R” or “L” markings on the enclosure body with the arrows on each axis. This will ensure the OMNIBot Cutting Guide is in the proper position during the varus/valgus orientation adjustment (i.e. between the distal and anterior resections).

Attaching the OMNIBot:

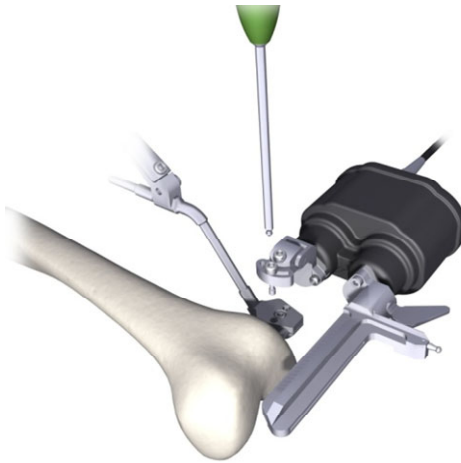

Attach the OMNIBot onto the Fixation Base (#4145-5100 or NS-06762) by inserting the centering post of the orientation adjustment interface piece into the outermost hole on the base (i.e. the hole that is the furthest away from the bone). Insert the sliding (loose) screw into the innermost hole of the base (i.e. the hole that is the closest to the bone). Tighten the screws with the H3.5 screwdriver (KS-62030). Insert an OMNIBot Saw Guide mounted with the “G” reference in the dove tail groove. Lock it in a position just far enough from the bone to allow movement of the OMNIBot around the femur.

Aligning the OMNIBot with the plan (Varus/Valgus & Axial Rotation):



WARNING: Before the navigation of femoral cuts, it is strongly recommended to check that the F reference has not moved by placing the Pointer on the bone surface.

If the displayed distance (See §2.9) from the Pointer to the bone is more than 1.0mm in reliable areas of the reconstructed bone model, the references have certainly moved. Accuracy is no longer guaranteed, and the Femur should be re-registered (Axis and Bone Morphing) or user should revert to a conventional surgical protocol.

The screenshot shows the OMNIBot™ ALIGNMENT software interface. The top bar includes 'FTP G', 'OMNIBot™ ALIGNMENT', and 'Corin'. The interface is split into two 3D views of a knee joint. The left view shows '1° VARUS' and '1.0° VALGUS' with a purple arrow indicating adjustment. The right view shows '3° EXT' and '6.0° EXT' with a blue arrow indicating adjustment. A purple screw adjustment indicator is visible on the left view, and a blue/green screw adjustment indicator is visible on the right view. The bottom bar contains navigation and control icons, including 'Menu', 'L', '2° VAL', and '122° FLEX'. Labels with green lines point to various elements: 'Check planned cut varus/valgus' points to the top left; 'OMNIBot varus/valgus' points to the left 3D view; 'Check planned axial rotation' points to the top right; 'OMNIBot axial rotation' points to the right 3D view; 'Check purple screw adjustment indications' points to the purple arrow; 'Check 2nd screw adjustment indications' points to the blue/green arrow; 'Check planned implant alignment on 3D views (White)' points to the white lines; and 'Control OMNIBot alignment on 3D views (Blue/Green)' points to the blue/green lines.

- Loosen purple screw and align the OMNIBot varus/valgus following the direction shown on the left side of the screen. Lock the screw when it turns green and the blue and white lines are aligned on the left side of the screen.

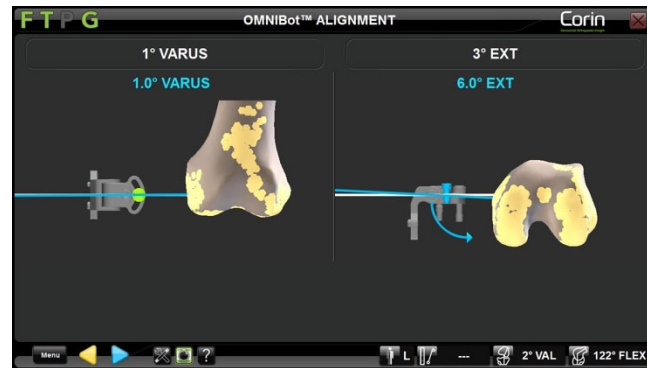

Note: if only one screw is set the varus/valgus may not correspond to the planned value. It will match once both screws are adjusted to the planned position.

- Loosen the grey screw and align the OMNIBot axial rotation following the direction shown on the right-hand side of the screen. Lock the screw when it turns green and the blue and white lines are aligned on the right side of the screen.

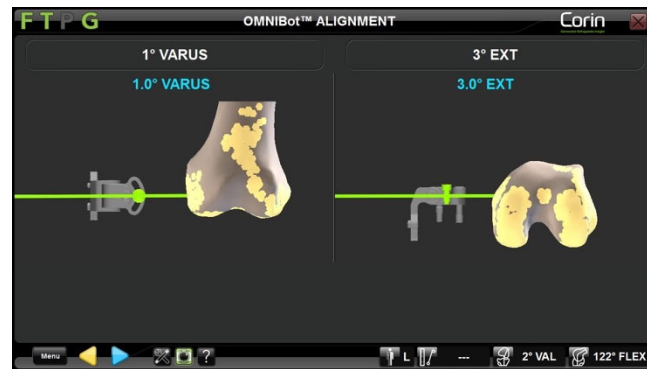

Note: Once the two screws turn green the lines also turn green to indicate the planned alignment is reached.

- Touch  to validate the OMNIBot alignment.

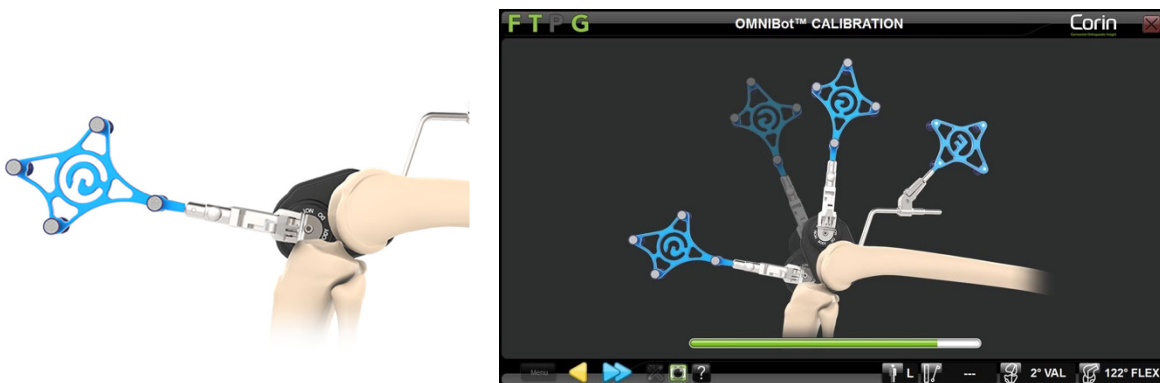

Calibrating the OMNIBot:

- Place the OMNIBot Saw Guide in the most posterior position possible by rotating the two OMNIBot axes. Make sure that the OMNIBot Saw Guide is slid far enough from the bone and is tightly locked into position.



Note: The OMNIBot Saw Guide must be engaged over the entire length of the dove tail groove to guarantee accuracy of the calibration.

- Touch  and hold it down throughout the entire calibration process of the OMNIBot. The acquisition will complete when the green bar fills up and the OMNIBot will position itself for the first cut.

	WARNING: Before each OMNIBot movement make sure to move back the OMNIBot Saw Guide in order to avoid any conflict with the bone.
	WARNING: During the calibration of OMNIBot and for each cut check that the OMNIBot Saw Guide is securely locked into place. If this is not the case the accuracy of the system could be affected.
	WARNING: Do not disconnect OMNIBot (i.e. emergency stop button pressed, or cable disconnected) after the calibration has been completed. This will require the OMNIBot to be recalibrated.

Moving the OMNIBot to each femoral cut:

The OMNIBot will move to five successive cut positions. The default order of the cuts is: Distal / Anterior / Posterior / Anterior Chamfer / Posterior Chamfer. For more details about predefined profiles refer to §5.2.

- Touch  and hold it down until the OMNIBot is locked in position on the following cut.

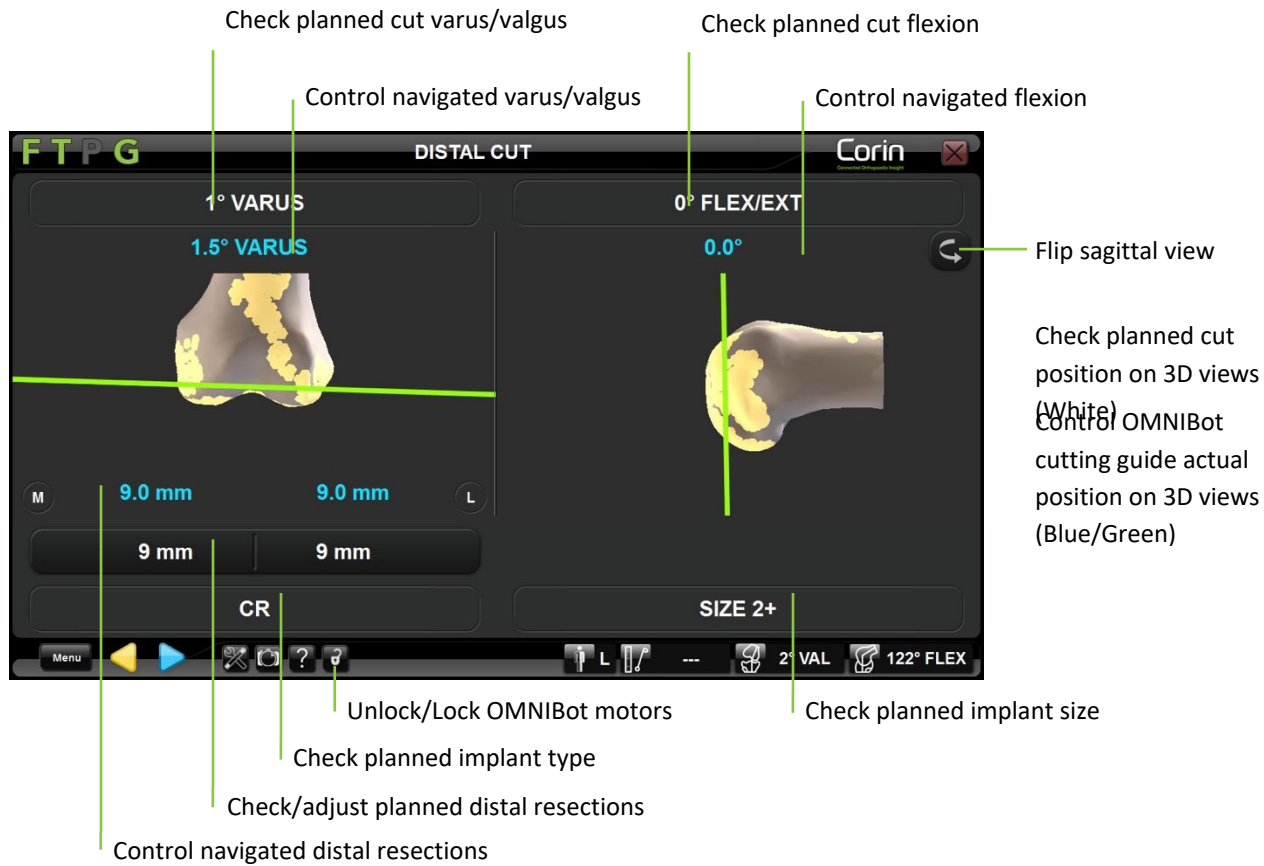

Repositioning the OMNIBot Saw Guide:

If required, some cuts can be adjusted directly from cut navigation page. Adjusting the cut height will shift the planned implant position by the corresponding value in the direction of the adjustment.

- Touch parameter button to be adjusted then touch +/-.

Note: The following parameters can be adjusted directly from cut navigation page:

- Distal resection from Distal Cut Navigation page
 - AP position from Anterior Cut Navigation if it is placed before Posterior Cut and Chamfers Cuts in the user profile.
 - Posterior resection (i.e. AP position) from Posterior Cuts Navigation page if it is placed before Anterior Cut and Chamfers Cuts in the user profile.
- Touch and hold  to move the OMNIBot to the new position.

Note: The successive cuts will automatically be updated according to these new positions. Planning a recut does not change the planned femoral prosthesis size



RECOMMENDATION: Adjusting cuts after some of the cuts have already been performed may result in a gap between the prosthesis and the bone, depending on the direction the implant is shifted in. These gaps may need to be filled with cement. If you wish to downsize the prosthesis after performing some or all of the cuts, return to the femoral planning page and change the implant size and position as required.



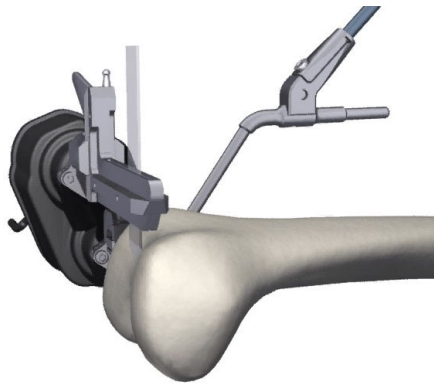

Perform the Femoral Cuts:

- Slide the OMNIBot Saw Guide towards the bone without making contact to reduce skiving of the saw blade. Secure the guide before making the cut.

	RECOMMENDATION: When sliding the OMNIBot Saw Guide forward before each cut, do not place it or force it into direct contact with the bone so as not to affect the position of the OMNIBot Saw Guide. Do not apply excessive force on the OMNIBot Saw Guide or on the motors while making the cut.
---	--



Cut the femur using a **1.27mm** thick saw blade.

	WARNING: Before performing each cut, check the position of the OMNIBot Saw Guide by attaching the “G” reference onto the OMNIBot Saw Guide and verifying the position values on the navigation screen.
	WARNING: Only use 1.27mm blades with the OMNIBot Saw Guide.
	WARNING: For optimal cut accuracy apply minimal force to the OMNIBot Saw Guide while performing a cut.
	WARNING: Check that the saw guide is properly secured in position before performing a bone cut. If this is not the case the accuracy of the system will be affected.



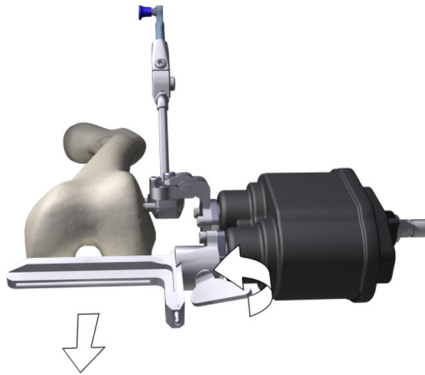

WARNING: The heat caused by the saw blade in an OMNI saw guide is identical to a standard cutting block. In case of overheating spray the saw guide with water.



After completing a cut, pull back the saw guide to avoid contact with the bone as the OMNIBot positions the saw guide for the next cut.

- Touch and hold  to move the OMNIBot to the next cut position.

Unlocking the OMNIBot motors: Touch  at any time during femoral navigation. It is possible to move the axes manually and locking them into a different position by touching .

Switching to NanoBlock instrument option: If necessary, physically disconnect the OMNIBot cable from the OMNIBot or from the station and follow the indications from the disconnection message on screen to switch to the NanoBlock option.



WARNING: Switching to the NanoBlock is a backup procedure in case of OMNIBot failure. Switching to the NanoBlock will introduce some changes in the workflow and it will not be possible to switch back to OMNIBot. Refer to §4.14.

4.18 Cut Validation

Position the Validation Plate:



Use the push button to attach the “G” reference (#0501-5070 or NS-300G4) to the Validation Plate (#4161-5400 or NS-40500 or NS-54035 for Apex Knee and #NS-54035 for Unity Knee).

Validate the Tibial Cut position:

Check planned cut varus/valgus

Control actual cut varus/valgus

Check planned cut slope

Control actual cut slope

0° VAR/VAL

4° POST

1.5° VARUS

3.0° POST

Flip sagittal view

Check planned cut position on 3D views

Control actual cut position on 3D views

8.0 mm

9.0 mm

8 mm

10 mm

Check planned cut resections

Control actual cut resection

FT PG

TIBIAL CUT VALIDATION

Corin

Menu

L

2° VAL

139° FLEX

- Place the Validation Plate equipped with the “G” reference flat on the tibial cut and check the actual cut position.

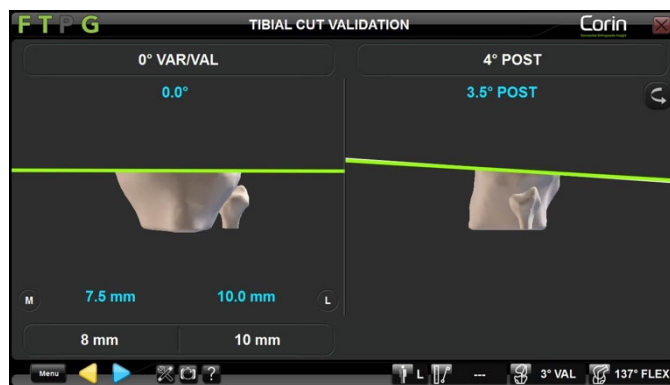

- Touch  to record the tibial cut position and proceed to the next step.

Validate the Distal Cut position:

The screenshot shows the 'DISTAL CUT VALIDATION' interface. On the left, a 3D model of a knee joint is shown with a planned cut line. The planned cut is labeled '1° VARUS' and the actual cut is '1.5° VARUS'. Below this, there are two '8.5 mm' resection controls for the medial (M) and lateral (L) sides, and two '9 mm' resection controls. A 'CR' (Center of Rotation) control is also present. On the right, a 3D model of a hand/wrist is shown with a planned cut line. The planned cut is labeled '0° FLEX/EXT' and the actual cut is '1.5° EXT'. A 'Flip sagittal view' button is located next to the 3D model. At the bottom, there are 'SIZE 2+' controls and a status bar showing '2° VAL' and '122° FLEX'. The interface includes a 'Menu' button, navigation arrows, and a help icon.

Annotations with green lines pointing to specific features:

- Check planned cut varus/valgus (points to '1° VARUS')
- Control actual cut varus/valgus (points to '1.5° VARUS')
- Check planned cut flexion (points to '0° FLEX/EXT')
- Control actual cut flexion (points to '1.5° EXT')
- Flip sagittal view (points to the flip button)
- Check planned cut position on 3D views (points to the 3D model)
- Control actual cut position on 3D views (points to the 3D model)
- Check planned cut resections (points to the '8.5 mm' controls)
- Control actual cut resections (points to the '9 mm' controls)

- Place the Validation Plate equipped with the “G” reference flat on the distal cut and check the actual cut position.

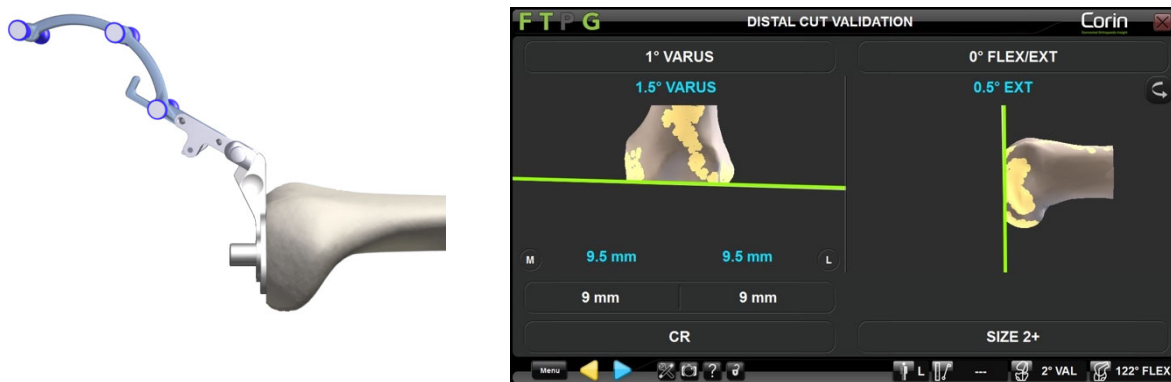

- Touch  to record the distal cut position and proceed to the next step.

Validate the Anterior Cut position:

The screenshot shows the 'ANTERIOR CUT VALIDATION' software interface. The interface is divided into several sections:

- Top Left:** Planned cut rotation is set to 3° EXT, and the actual cut rotation is 3.0° EXT.
- Top Right:** Planned cut flexion in implant referential is 0° FLEX/EXT, and the actual cut flexion is 2.5° FLEX.
- Center:** Two 3D views of a knee joint are shown. The left view is a medial view (M) and the right view is a lateral view (L). A blue line indicates the planned cut position. A 'Flip sagittal view' button is located between the two views.
- Bottom Right:** The anterior cut position is 2.5 mm ANT. Below this, there are controls for '0 mm' and 'SIZE 2+'.
- Bottom Left:** The implant type is set to 'CR'.
- Bottom Center:** The implant size is set to 'SIZE 2+'.
- Bottom Right:** The planned cut position from the anterior referential is 2° VAL, and the actual cut position from the anterior referential is 122° FLEX.

Annotations with green lines point to the following elements:

- Check planned cut rotation (points to 3° EXT)
- Control actual cut rotation (points to 3.0° EXT)
- Check planned cut flexion in implant referential (points to 0° FLEX/EXT)
- Control actual cut flexion in implant referential (points to 2.5° FLEX)
- Flip sagittal view (points to the flip button)
- Check planned cut position on 3D views (points to the 3D views)
- Control actual cut position on 3D views (points to the 3D views)
- Check planned implant type (points to CR)
- Check planned implant size (points to SIZE 2+)
- Check planned cut position from anterior ref. (points to 2° VAL)
- Control actual cut position from anterior ref. (points to 122° FLEX)

- Place the Validation Plate equipped with the “G” reference flat on the anterior cut and check the actual cut position.

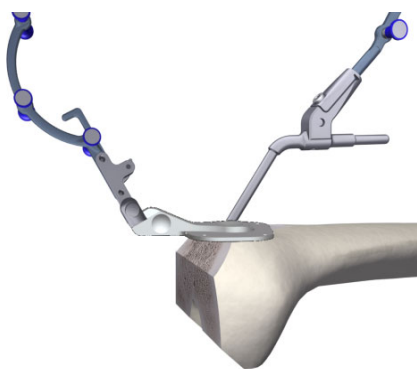

- Touch  to record the anterior cut position and proceed to the next step.

Note: It is important to carefully validate femoral anterior cut as this information will be used by the system to calculate position of the implant for final alignment.

	<p>RECOMMENDATION: When the cuts have been made, the system repositions the implants on the performed cuts. It is possible in some cases (major varus or valgus) that the system cannot determine an optimal position for the prosthesis on the performed cuts. In this case (a dialogue box is displayed), you can either slightly modify the cut and record its position again or continue using conventional surgical protocol.</p>
	<p>RECOMMENDATION: During the performed cut digitization stage, make sure the Validation Plate is correctly placed on the cut plane and covers as much surface as possible.</p>

4.19 Final Balance Assessment with the BalanceBot

Prepare the BalanceBot:



With the correct Tibial Plate and correct Femoral Paddles tightly attached to the BalanceBot (See §4.12 for more details), select the pair (A+B) of Insert Trials that match the Femoral Component Trial size of the implant used and place them onto the corresponding Femoral Paddles of the BalanceBot. Insert sizes 1-3 and 4-6 go with Paddle size 2 and 4, respectively. Insert A goes with Paddle A and Insert B goes with Paddle B.



WARNING: The insert trials are specific to each implant (Apex Knee and Unity Knee). Make sure that you are using the appropriate inserts for the used implant before assessing the final stability of the joint with the BalanceBot or they could not match the actual implant articular surface.

Connect the BalanceBot to the Station: See §4.12 for more details

Note: Connection is required at this stage if the BalanceBot has not been already connected for use for active ligament balancing.

Calibrating the BalanceBot: See §4.12 for more details

Note: Calibration is required at this stage if the BalanceBot has not been already calibrated for use for active ligament balancing or if the BalanceBot has been disconnected since last calibration.

Final Balance Assessment with BalanceBot in Force Control Mode:

During Final Balance Assessment in Force Control Mode, the BalanceBot will be applying a targeted distraction force to both the medial and lateral compartments and ART Knee Software will be measuring the resulting gaps.

Note: By default, the BalanceBot is ready to be used In Force Control Mode. If needed, press the Mode button to switch the BalanceBot to Height Control Mode.

Check Gaps at 10° and 90° flexion

Set target Force

Switch the BalanceBot back and forth from Force Control Mode to Height Control Mode

Retract the BalanceBot to lowest position (Home)

Toggle forces display between Pounds and Newtons

Engage/Release the BalanceBot

- With the Femoral Trial in place, insert the BalanceBot into the knee joint.

Reminder: At this stage, the Spacer must be used with Insert Trials that fit the Femoral Trial size

- Set target force (default 80N at 0°). Adjust force as desired to preferred tension. Ensure the ankle is free to move mediolaterally when acquiring gap in extension.

Note: If the BalanceBot has been used for Initial Balance Assessment then the target force proposed by default will be the same as the force used for Initial Balance Assessment with the BalanceBot.

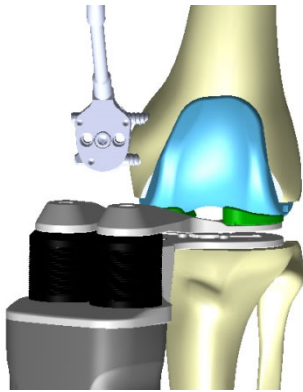

- Touch  to engage the BalanceBot and to apply target force to each compartment of the knee joint.

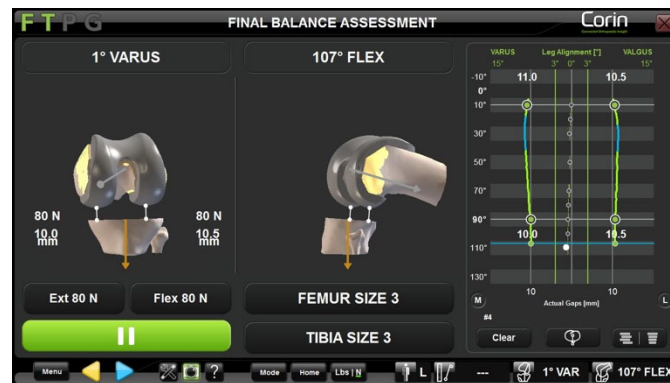
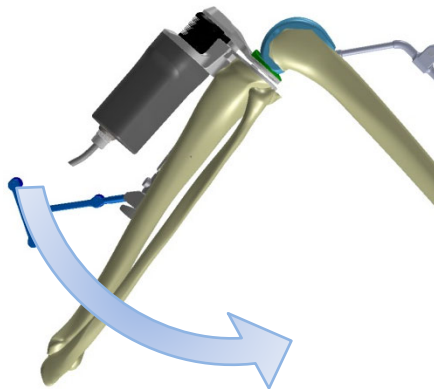

- Acquire gaps dynamically throughout flexion by slowly flexing the leg from full extension to maximum flexion. Support the femur from the back of the knee during the acquisition to minimize the influence of the weight of the femur on the gap measurements.
- Check on screen gaps along with alignment and flexion data as knee is brought through a full range of motion.

Note: The BalanceBot will smoothly interpolate the applied force throughout the range of flexion/extension if different target forces are selected for extension and flexion. The graph will show corresponding gap measurements, plotted as a curve relative to flexion angle, throughout the full range of motion; gap values captured at 0° and 90° flexion will be specially highlighted.

Note: Touch the actual gap graph anywhere between extension and 90° flexion to display a scan line indicating the amount of gap opening between the measured gap curves and the selected tibial insert in that flexion position of the leg.

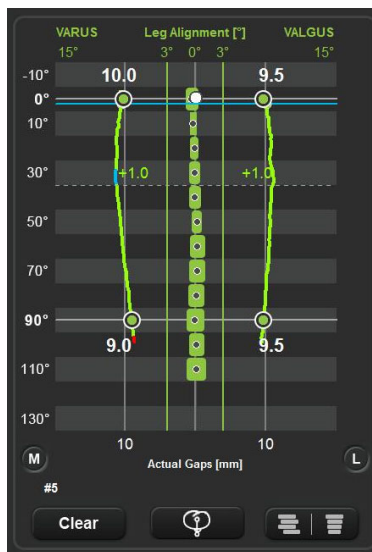

Final Balance Assessment with BalanceBot in Height Control Mode:

In Height Control Mode, the BalanceBot will position the medial and lateral inserts at a constant height corresponding to the targeted selected Insert height for the implant used and will measure and display the resulting overall force in each compartment of the knee joint.

- Touch the “MODE” button to switch the BalanceBot from Force Control Mode to Height Control Mode.

Note: The Spacer will remain active when switching from Height Control Mode. The software will automatically propose to use the insert thickness validated during Femoral Planning, or the thinnest available insert if the BalanceBot is used for Final Balance Assessment only.

Control real time Medial Force & Gap

Control current Varus/Valgus of the leg

Control real time Lateral Force & Gap

Control current Flexion/Extension of the leg

Check knee alignment throughout extension flexion range of motion

Toggle forces display between Pounds and Newtons

Retract the BalanceBot to lowest position (Home)

Switch the BalanceBot from Height Control Mode to Force Control Mode

Engage/Release the BalanceBot

Set target insert height

- With the Femoral Trial in place, insert the BalanceBot into the knee joint.
Reminder: At this stage, the BalanceBot must be used with Insert Trials that match the Femoral Trial size of the implant used.
- Set target insert height (default: thinnest insert or planned insert height).

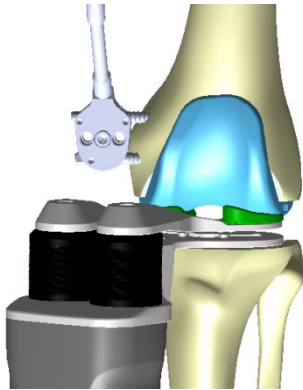

- If the BalanceBot is not yet engaged, touch  to engage the BalanceBot and to go to the desired height.
Note: The Spacer will maintain accurately targeted height under external dynamic forces from 0 to 150N.

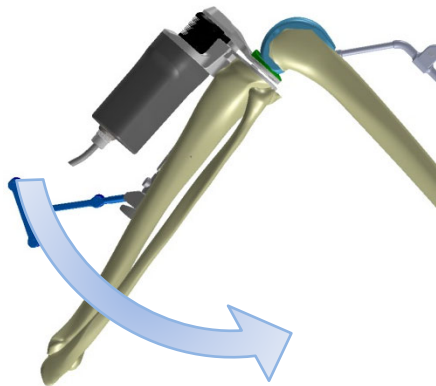

- Check the on screen the alignment and flexion data as the knee is brought through a full range of motion. The knee may be stressed into varus and valgus using the force readings to control the applied load.
- At this stage the BalanceBot height and the rotation of the Tibial Plate on the tibia may be adjusted as required to correct for inappropriate stability or unbalanced forces between the medial and lateral compartments of the knee joint.



WARNING: Ensure sufficient knee laxity before increasing the height of the active-spacer trial. Increasing the height without sufficient laxity may result in high tension applied to the ligaments



Note: During Final Stability Assessment in Height Control Mode it is possible to display Forces captured at 0°, 10°, 45° and 90° on the graph. To activate this option touch the **Forces** button on the screen.

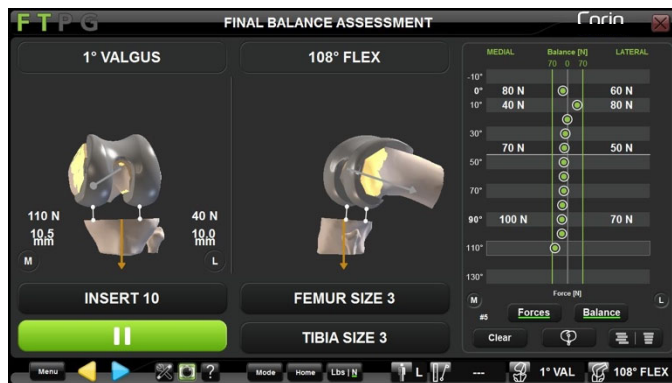

Note: During Final Stability Assessment in Height Control Mode it is possible to display a live feed showing the level of balance between the two compartments of the knee joint. Lines indicating 70N of unbalance between the medial and lateral compartments are represented on the graph to aid the user in assessing the degree of balance. To activate this option touch the **Balance** button on the screen.

BalanceBot visual warnings

The BalanceBot is designed to provide accurate force control measurement from 20N to 200N but it can measure and sustain higher forces up to 300N for a short period of time when used in Height Control Mode. To preserve the accuracy of the device and to avoid damage to any internal components, a few controls have been implemented in the software to visually notify the user when the Spacer is used out of range and when precautions should be taken.

- BalanceBot Overload

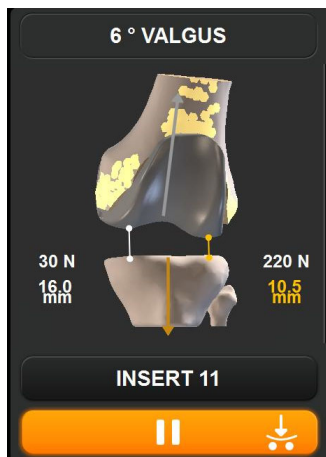

In Height Control Mode, if the force applied to the BalanceBot reaches 200N then the BalanceBot Play/Pause button will turn Orange and will indicate that the BalanceBot is overloaded. The BalanceBot can support such load for 15 seconds. This warning will disappear as soon as force applied to the BalanceBot are less than 200N.

Note: This overload condition should not normally be experienced until leg is brought into maximal extension.

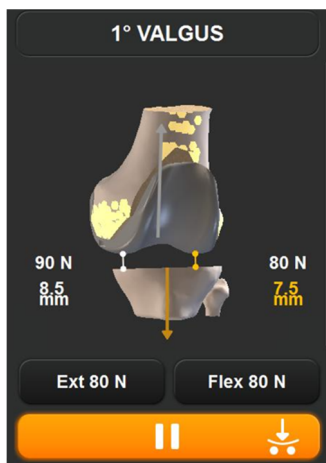

In Force Control Mode, if the gaps are so tight that the Femoral Paddles are touching the Tibial Plate under the commanded force then the BalanceBot Play/Pause button will turn Orange and will indicate that the BalanceBot is overloaded. This warning will disappear as soon as gaps will open up to a minimum of 8 to 9mm depending on the insert trials used.

Note: This overload condition indicates that the Force applied to the knee might exceed what is indicated on the screen.

- BalanceBot Safe Mode

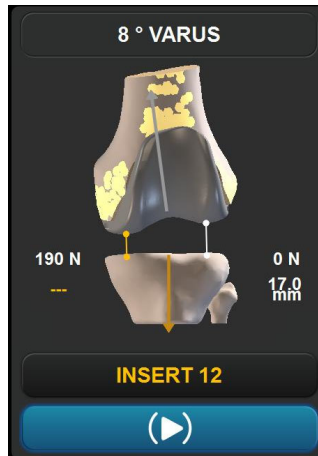

In Height Control Mode, if the BalanceBot is overloaded above 200N for more than 15 seconds or if the load reaches 450N, it will automatically go into Safe Mode and the BalanceBot Play/Pause button will turn Blue indicating the system is in ‘Safe Mode’. In Safe Mode the targeted height of the BalanceBot is no longer maintained so the gap measurement is not reported and the BalanceBot automatically retracts to a position such that the applied force is less than 200N.

Note: When the BalanceBot is in Safe Mode it cannot be used to assess knee stability as it is not maintaining a constant height.

- BalanceBot Overheating

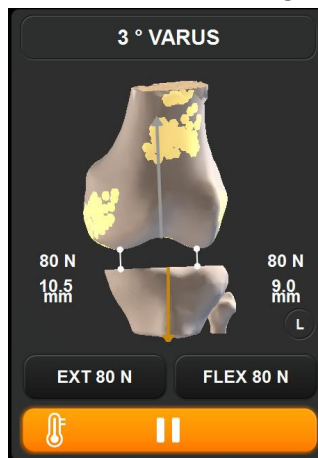

When the BalanceBot is connected, ART Knee Software is monitoring the temperature indicator of the device. When the indicator reaches a certain threshold then the BalanceBot Play/Pause button will turn Orange indicating that the BalanceBot is overheating. The BalanceBot can support heat for some time. This warning will disappear as soon as the spacer is placed in Standby (Paused) Mode allowing the BalanceBot to cool down.

Note: If the BalanceBot temperature indicator keeps increasing then eventually the device may be automatically placed into Standby and the user will be notified via an on-screen message. The BalanceBot will not be able to engage until it cools down.

Ligament releases and bone recuts (Optional):

Based on the observed forces, gap readings and assessed knee stability, the surgeon must use their surgical judgement to decide if ligaments need to be released or recuts need to be performed.

- If required, release the appropriate ligament structures with a scalpel or needle in either Force or Height Control Mode.
Note: If possible, keep the BalanceBot engaged into the knee joint to observe and assess the change ligaments in gaps readings (Force Control Mode) or forces reading (Height Control Mode) as a result of releases performed.
- If required, proceed to bone recut(s) using the Menu to navigate to tibial or femoral recuts as required (See §4.22 for more details).

Register final force and gap readings:

Take the knee through a range of motion to record the final gaps and/or force readings. The rotation of the Tibial Plate on the tibia may be marked using the marking provided on the anterior aspect of the Tibial Plate. Touch  and remove the BalanceBot from the knee joint.

Note: The BalanceBot will automatically retract to its lowest position once  has been touched.

Punch the tibial keel – Apex Knee only:

The Tibial Plate is used to guide the Tibial Keel Punch Dart of the Apex Knee.

- Use the mark to reposition the Tibial Plate on the tibial cut after it has been disconnected from the BalanceBot.
- Pin the Tibial Plate fixed in its position using the Universal Handle and two Headed Pins from the Apex Knee instrumentation set.
- With the Tibial Plate firmly pinned into place, the Keel Punch from the Apex Knee instrumentation set is used to create the cavity for the Tibia Component's keel.

Note: For more details about the Tibia Bone Preparation with the Apex Knee instrumentation set refer to the Apex Primary Knee Surgical Technique.

4.20 Leg Alignment and Kinematics acquisitions

Acquiring Pre-Operative Kinematics:

After Patient Anatomy Registration, mobilize and stress the knee joint. The maximal positions of the leg are automatically registered and displayed on the graph on the screen. The application allows registration of maximal extension and maximal flexion as well as registration of maximal Varus/Valgus every 10° of flexion from 10° hyperextension to 150° flexion.

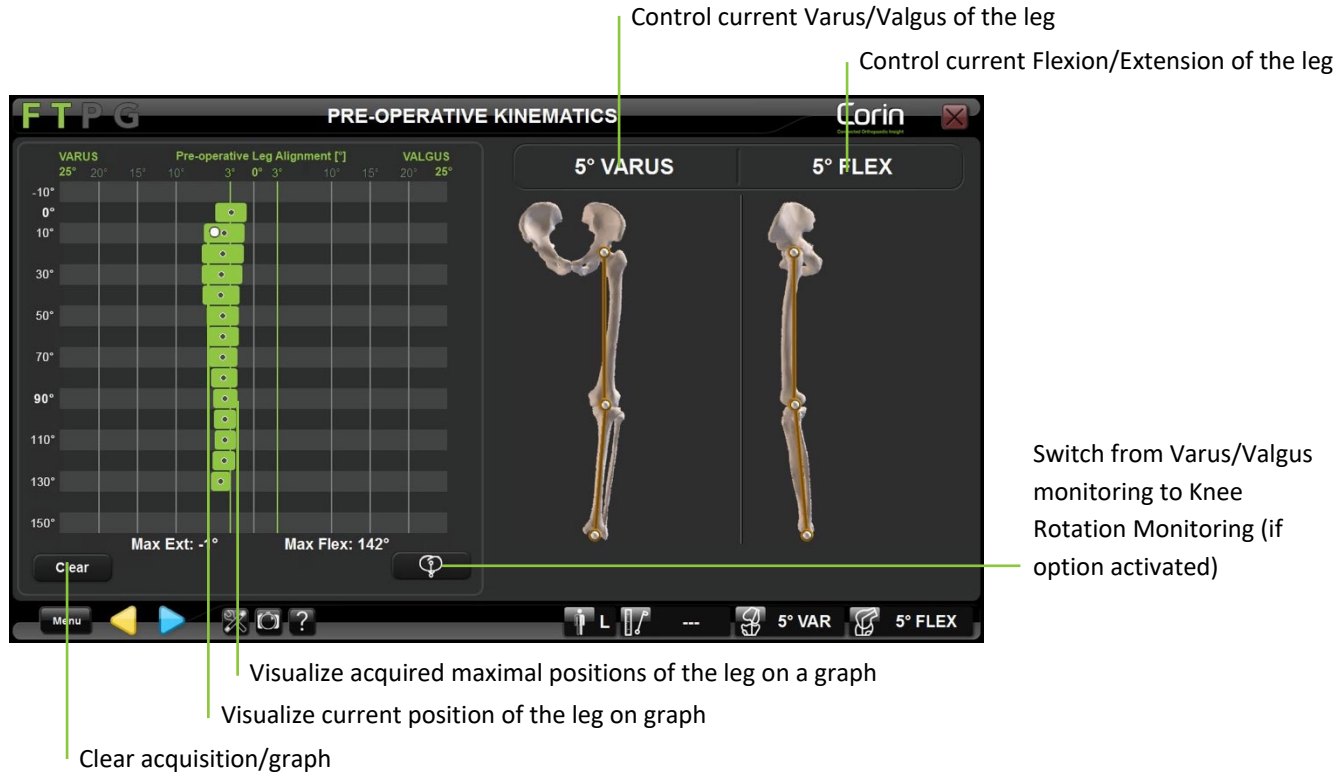

Record the acquisition: Touch  .

Note: Leg alignment information displayed on screen when validating Pre-Operative Kinematics is stored in a surgical report generated by the software as Pre-Operative Axis Alignment.

Acquiring Post-Operative Kinematics:

With implants or trials in place, mobilize and stress the knee joint. The maximal positions of the leg are automatically registered and displayed on the graph on the screen.

The application allows monitoring leg alignment and implant gaps, registration of maximal extension and maximal flexion as well as registration of maximal Varus/Valgus every 10° of flexion from 10° hyperextension to 150° flexion.

The screenshot shows the Corin FTPG POST-OPERATIVE KINEMATICS interface. It features two 3D knee joint models on the left, a central graph, and several control buttons. The 3D models show medial (M) and lateral (L) views with implant gaps of -1.0 mm and -0.5 mm. The graph plots Varus, Leg Alignment, and Valgus against flexion angles from -10° to 130°. The interface includes buttons for 'INSERT 11', 'FEMUR SIZE 2+', 'CR', and 'TIBIA SIZE 2'. A bottom toolbar contains navigation and monitoring controls.

Control current Varus/Valgus of the leg

Control current Flexion/Extension of the leg

Visualize current position of the leg on graph

Compare pre-op and post-op graphs

Switch from Varus/Valgus monitoring to Knee Rotation Monitoring (if option activated)

Visualize acquired maximal positions of the leg on a graph

Reset/Clear graph

Adjust femoral implant size (if available) and tibial implant size

Adjust tibial insert thickness

Change femoral implant type (if available)

Check medial and lateral implant gaps measured between femoral implant and tibial insert

Adjust tibial insert thickness: Touch “INSERT” button then touch +/-.

Note: Selected insert thickness information is used in the calculation of implant gaps. It should correspond to actual insert used for proper data interpretation.

Adjust femoral implant size – Apex Knee only: Touch “FEMUR SIZE” button then touch +/-.

Note: Femoral implant size adjustment is limited to standard or “+” size.

Adjust tibial implant size: Touch “TIBIA SIZE” button then touch +/-.

Adjust implant type: Touch “CR” or “PS” button then touch </>.

Compare Pre-op and Post-op kinematics: Touch  .

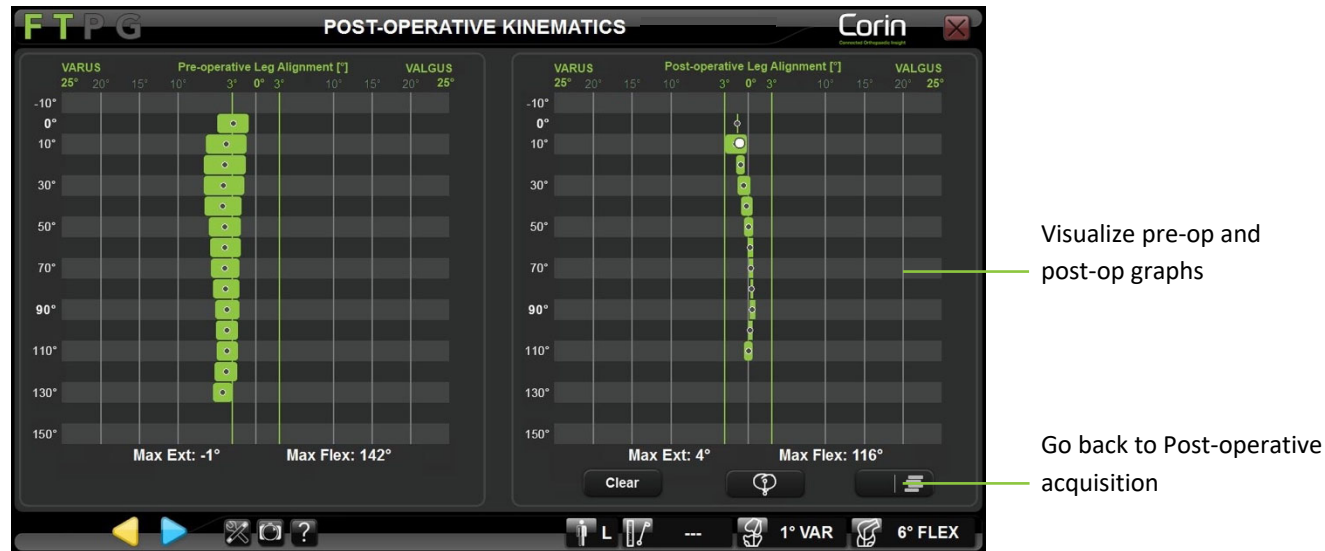

Record final leg alignment: Touch  .

Note: Leg alignment information displayed on screen when validating Post-Operative Kinematics is stored in a surgical report generated by the software as Post-Operative Axis Alignment.

4.21 Knee Rotation Monitoring

The Knee Rotation Monitoring function allows a user to switch from Varus/Valgus monitoring to femorotibial rotation monitoring. Femorotibial rotation is calculated as the angle between the tibial mediolateral axis and the femoral mediolateral axis projected on the tibial axial plane. This function is enabled in the user profile settings and can be used during the following steps:

- Pre-Operative Kinematics;
- Final Stability Assessment with the BalanceBot;
- Post-Operative Kinematics.

Knee Rotation Monitoring during Pre-Operative Kinematics: Touch

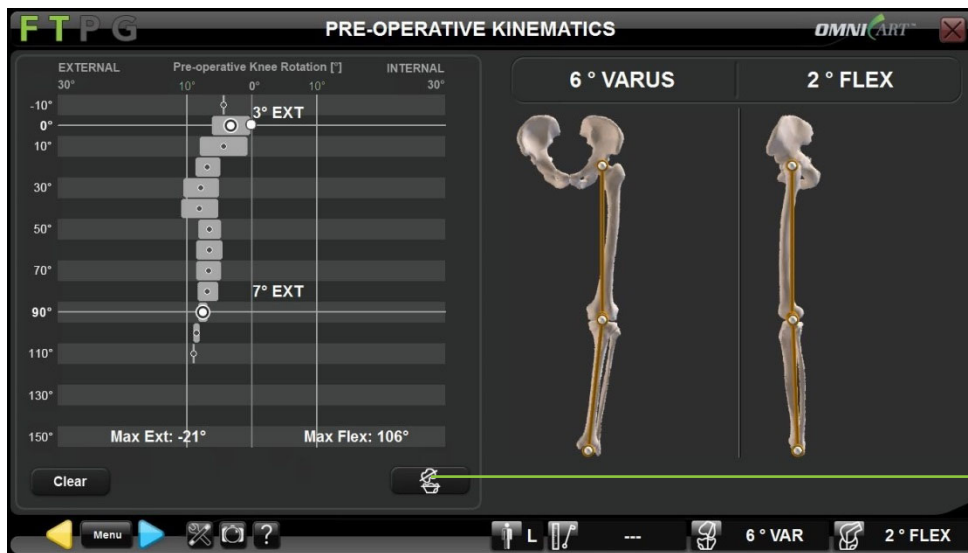

Switch back to
Varus/Valgus monitoring

Knee Rotation Monitoring during Final Balance Assessment with the BalanceBot: Touch



Switch back to
Varus/Valgus monitoring

Knee Rotation Monitoring during Post-Operative Kinematics: Touch



Switch back to
Varus/Valgus monitoring

4.22 Modular Tibia Implant – Apex Knee only

The Modular Tibia option allows a user to switch from Standard tibia implant to Modular tibia implant (See §4.8, 4.13, and 4.14 for more details). Selecting the Modular tibia implant will automatically default the Tibial Slope to 0° and the Tibial Resection to +2mm. In addition, gap measurements will take into account the extra 2mm thickness of the Modular base plate in order to maintain the consistency of the gap measurements with the Tibial Insert nominal thickness. When selected during Tibia Planning or Tibia Navigation steps, the Modular tibia implant will be taken into account for gap measurements during the following steps:

- Ligament Balance in Extension and Ligament Balance in Flexion;
- Initial Balance Assessment with the BalanceBot;
- Final Balance Assessment with the BalanceBot;
- Post-Operative Kinematics.

Ligament Balance in Extension and Ligament Balance in Flexion:

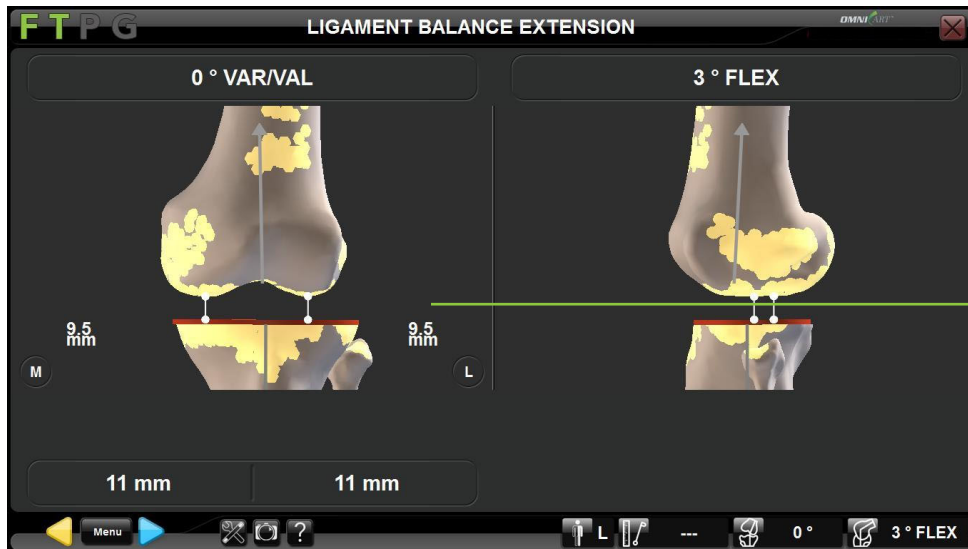

Gaps displayed are corrected by 2mm to take into account the extra thickness of the Modular Tibia Implant

Initial Balance Assessment with the BalanceBot:

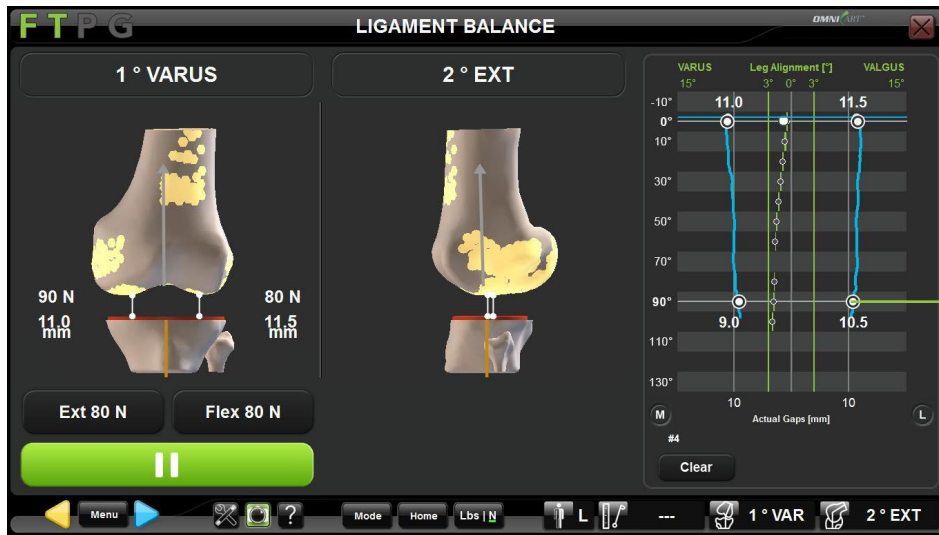

Gaps displayed are corrected by 2mm to take into account the extra thickness of the Modular Tibia Implant

Femoral Planning with the BalanceBot:

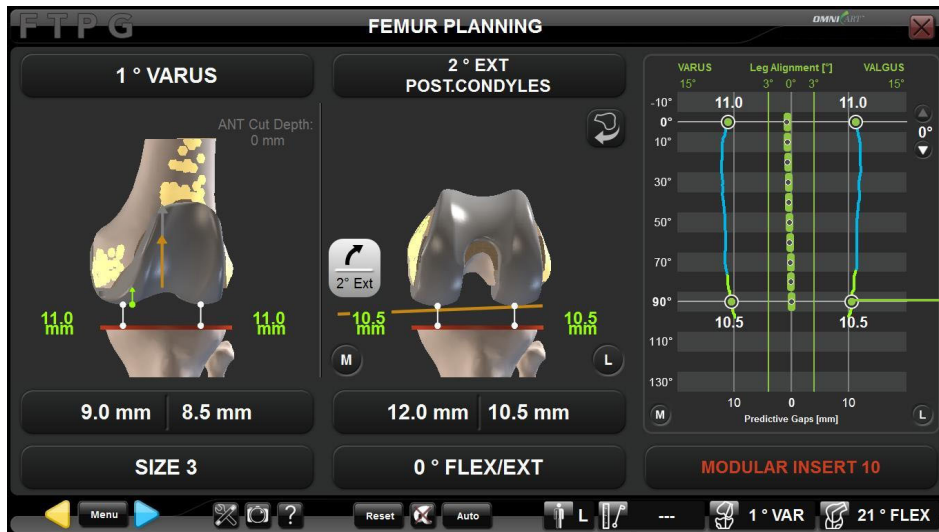

Gaps displayed should match the selected insert thickness

Final Balance Assessment with the BalanceBot:

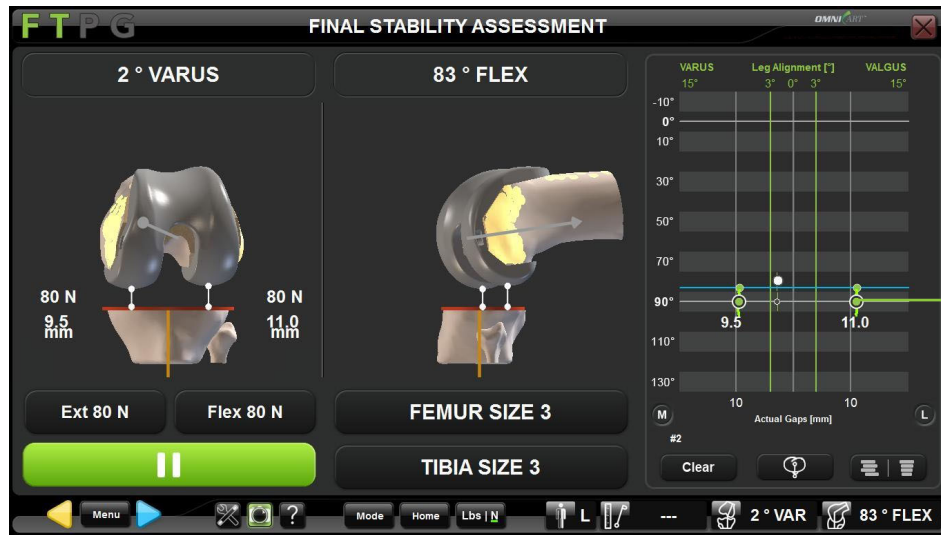

Gaps displayed should match the selected insert thickness

Post-Operative Kinematics:



4.23 Re-cutting the Femur after all cuts have been made

Using the menu, it is possible to recut the femur after all femoral cuts have been made, for example from the Final Balance Assessment or Post-Operative Kinematics screens. Recuts can be performed with the NanoBlock™ or with the OMNIBot™.

Femoral recut with the NanoBlock:

- Touch **Menu** to open the Menu and select “Femoral Cuts” and “Cut/Recut All”.



- Double click the “Cut/Recut All” button or touch **Go** .
- Adjust the NanoBlock targeted cut position to the desired femoral distal cut position – refer to §4.15.
- Position the NanoBlock to the planned Distal Cut – refer to §4.15.
- Perform the Femoral Distal Cut – refer to §4.15.

Note: After Femoral Distal recut with the NanoBlock Femoral AP cut navigation is not required by the system. However, it is possible to place the appropriate size four-in-one distal femoral resection block back on the distal femur by driving the block pins into the previously drilled holes in order to shave bone off the anterior and chamfer resections.

Femoral recut with the OMNIBot:

- Touch **Menu** to open the Menu and select “Femoral Cuts” and “Cut/Recut All”.



- Double click the “Cut/Recut All” button or touch **Go**.
- Attach the OMNIBot onto the Femur Bone Fixation Base – refer to §4.17: Attaching the OMNIBot
- Align the OMNIBot Axis with the plan – refer to §4.17: Aligning the OMNIBot with the plan
- Re-calibrate the OMNIBot – refer to §4.17: Calibrating the OMNIBot

Note: If the OMNIBot has not been disconnected from the System then re-calibration is not required.

- Move the OMNIBot to the femoral distal cut – refer to §4.17: Moving the OMNIBot to each femoral cut
- Reposition the OMNIBot to the desired femoral distal cut position – refer to §4.17: Repositioning the OMNIBot cutting guide
- Perform the all five femoral Cuts – refer to §4.17: Perform the Femoral Cuts

Note: If the femoral distal cut is not the first of the five femoral cuts then it is not possible to adjust the distal resection directly from that step and the system requires you to go back to Femoral Planning to adjust the femoral distal resection.

In this case one should use Menu to go directly to “Femoral Cuts” and “Planning”. After the distal resection adjustment on the planning page the system will automatically go through the OMNIBot alignment, calibration and cut sequence process to proceed with the adjusted plan.

4.24 Navigation report

Adding information to the report:

Using the last screen of the procedure additional information can be added or edited to the report.

- Use the touchscreen or laptop trackpad to select the item to be edited.
- Use the laptop keyboard to type in information.

FINAL CASE INFORMATION

CORINCONNECT CASE ID:

HOSPITAL NAME:

SURGEON NAME:

PATIENT FIRST NAME:

PATIENT LAST NAME:

BIRTHDATE:

PATIENT HEIGHT: inches cm

PATIENT WEIGHT: lb kg

PATIENT GENDER: FEMALE MALE

OPERATED LEG:

COMMENTS:

TIMESTAMP: 2020-08-31.08-36-42

PATELLA SIZE:

PATELLA TYPE:

Menu 3° VAL 78° FLEX

Note: Patient Health Information edited here will be included in the PDF report generated by the system but it will not be saved onto the system and will not be sent to CorinConnect. At the end of the procedure it is possible to save the PDF report containing this information onto a USB key before it is permanently erased from the system.

Saving the navigation report to a USB key:

- At the end of the navigation protocol touch the “Exit” button.
- Insert a USB key into the laptop.
- Touch “Confirm” to record the navigation report.

Note: The navigation report includes a printable PDF report and a XLS sheet. The XLS sheet contains the numerical data for measurements performed during the navigation in a simple form. The navigation report folder also contains screenshots of all steps of the navigation protocol and all the manual screenshots saved during the navigation protocol (See §2.1).

4.25 CorinConnect Case ID

CorinConnect is your gateway to accessing Corin, the OPS™ technology and your OMNIBotics cases.



This portal allows for the creation and tracking of both OPS™ and Corin bookings including OMNIBotics cases and provides a secure system for uploading patient information.

The aim of CorinConnect is to increase the security around patient information management, increase the visibility of your OPS™, OMNIBotics and Corin case status, and provide you with more control over your cases.

Sign up to CorinConnect on <https://portal.coringroup.com> to obtain CorinConnect Case ID for your OMNIBotics cases.

For the best user experience, please use Google Chrome as your internet browser

For more information refer to your local Corin representative or see the “Portal User Guide OPT-REC-MK-19”.

	RECOMMENDATION: The booking of your OMNIBotics cases should occur before the beginning of the surgery as it will give you access to a CorinConnect Case ID required by the OMNIBotics Knee System at the beginning of the surgery (See §3.8).
	RECOMMENDATION: The CorinConnect Case ID should be recorded carefully for each patient so it can be accurately entered onto the OMNIBotics Knee System. The CorinConnect Case ID should always respect the following format: ABC-DE-12345 or ABC-DEF-12345



RECOMMENDATION: In case the CorinConnect case ID is not recognized by the OMNIBotics Knee System or if it cannot be retrieved before the start of the surgery, it is possible to use the following back-up ID:

EMG-CID-11937

In such case, we recommend you save the case data immediately at the end of the case on the USB key provided with the OMNIBotics Tracker Kit. An OMNIBotics case ID can be retrieved on the PDF report generated on the USB key that will allow you to link a late booking (after surgery) with corresponding OMNIBotics data on CorinConnect.

In the absence of case booking on CorinConnect the surgeon won't be able to retrieve OMNIBotics case data on CorinConnect.

5 Workflow Customization and Menu

5.1 Definitions

Navigation protocol = Surgical Protocol using the OMNIBotics Knee System

Step:

The ART Knee Software workflow is composed of a succession of steps. The User can navigate through steps using blue or yellow buttons or Menu.

Parent step:

A step that must be performed before another step can be accessed.

Children step:

A step that must be performed after another step has been performed (or validated).

Group:

Most steps belong to a predefined group of steps.

ART Knee Software groups are the following:

- Tibia Registration
- Femur Registration
- Tibial Cut (includes Planning, Navigation and Validation)
- Femoral Cuts (includes Planning, Navigations and Validations)
- Ligament Balancing (includes Extension and Flexion if the BalanceBot is not used)

Steps that are alone are considered as a group (group of 1 step). Example: Pre-operative Axis

Linear Workflow:

Default succession of steps as defined in a default profile or customized by the user in his user profile and defining the navigation protocol.

Nonlinear Workflow:

During a procedure it is possible to move out of the linear workflow to skip certain steps or redo steps generating a nonlinear workflow.

5.2 Default profiles

ART Knee Software is delivered with two default Profiles corresponding to recommended linear workflow for each implant:

Measured resections profile:

This default profile corresponds to a femur first measured resection technique using OMNIBot™ option for the femoral cuts navigation and NanoBlock™ for the tibial cut navigation. The BalanceBot will be used for the final balance assessment of the knee.

It includes the followings groups/steps:

- Patient Information (See §3.8)
- Instruments Calibrations (See §4.4)
- Reference & Camera positioning (See §4.5)
- Tibia Registration with Single Point Registration option (See §4.6)
- Femur Registration with “Light” OMNIBotics Bone Morphing™ option (See §4.6 and §4.7)
- Pre-operative Kinematics measurements (See §4.20)
- Femoral Cuts with the OMNIBot™
 - Femoral Planning (See §4.9)
 - Cuts Navigation with the OMNIBot (See §4.17)
 - Distal Cut Validation (See §4.18)
 - Anterior Cut Validation (See §4.18)
- Tibial Cut
 - Tibial Cut Navigation with the NanoBlock (See §4.14)
 - Tibial Cut Validation (See §4.18)
- Final Balance Assessment with BalanceBot (See §4.19)
- Post-operative Kinematics measurements (See §4.20)
- Final Information

Ligament balancing profile:

This default profile corresponds to a tibia first technique using initial balance assessment information to adjust the femoral planning. It includes the OMNIBot™ option for the femoral cuts navigation and NanoBlock™ for the tibial cut navigation. The BalanceBot will be used for both the initial balance assessment prior to femoral cuts and for the final balance assessment with trials.

It includes the followings groups/steps:

- Patient Information (See §3.8)
- Instruments Calibrations (See §4.4)
- Reference & Camera positioning (See §4.5)
- Tibia Registration with Single Point Registration option (See §4.6)
- Femur Registration with “Light” OMNIBotics Bone Morphing™ option (See §4.6 and §4.7)
- Pre-operative Kinematics measurements (See §4.20)
- Tibial Cut
 - Tibial Cut Navigation with NanoBlock (See §4.14)
 - Tibial Cut Validation (See §4.18)
- Initial Balance Assessment with BalanceBot (See §4.12)
- Femoral Planning with Active Ligament Balance information (See §4.12)
- Femoral Cuts with the OMNIBot:
 - Cuts Navigation with the OMNIBot (See §4.17)
 - Distal Cut Validation (See §4.18)
 - Anterior Cut Validation (See §4.18)
- Final Balance Assessment with BalanceBot (See §4.19)
- Post-operative Kinematics measurements (See §4.20)
- Final Information

5.3 Customized user profile setting

The user has access to several options and parameters which enables the customization of profiles according to the instruments used and individual surgical techniques. Once a profile has been defined, the navigation protocol will follow a linear workflow corresponding to the profile.

Accessing the User Profile setting options: On “User Profile Selection” page, touch the name of the profile to modify and touch MODIFY OPTIONS button (see §3.7). The default options correspond to the options of the profile selected. The options can be modified to create a profile corresponding to each surgical technique.

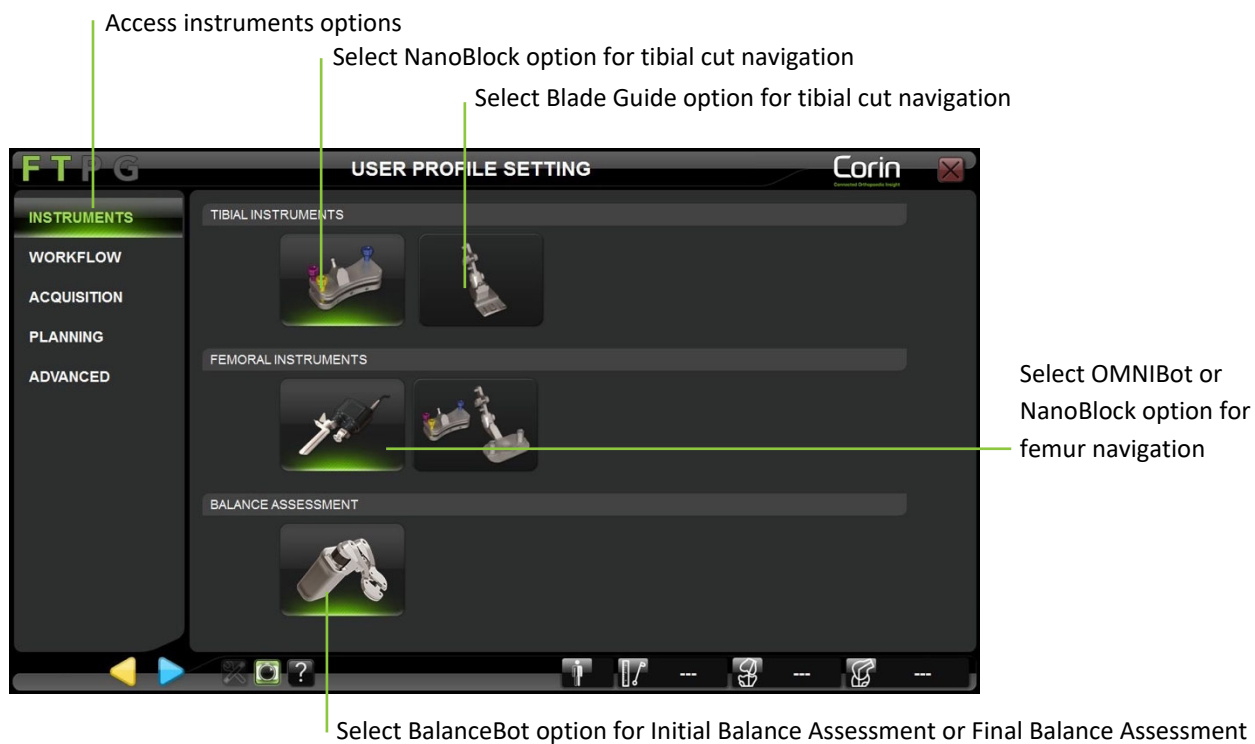

Modifying the instrument options: Touch “Instruments” tab and select the preferred instrument option for Tibial and Femoral cuts navigation as well as preferred instrument option for Ligament Balancing.

Note: The following options are currently available

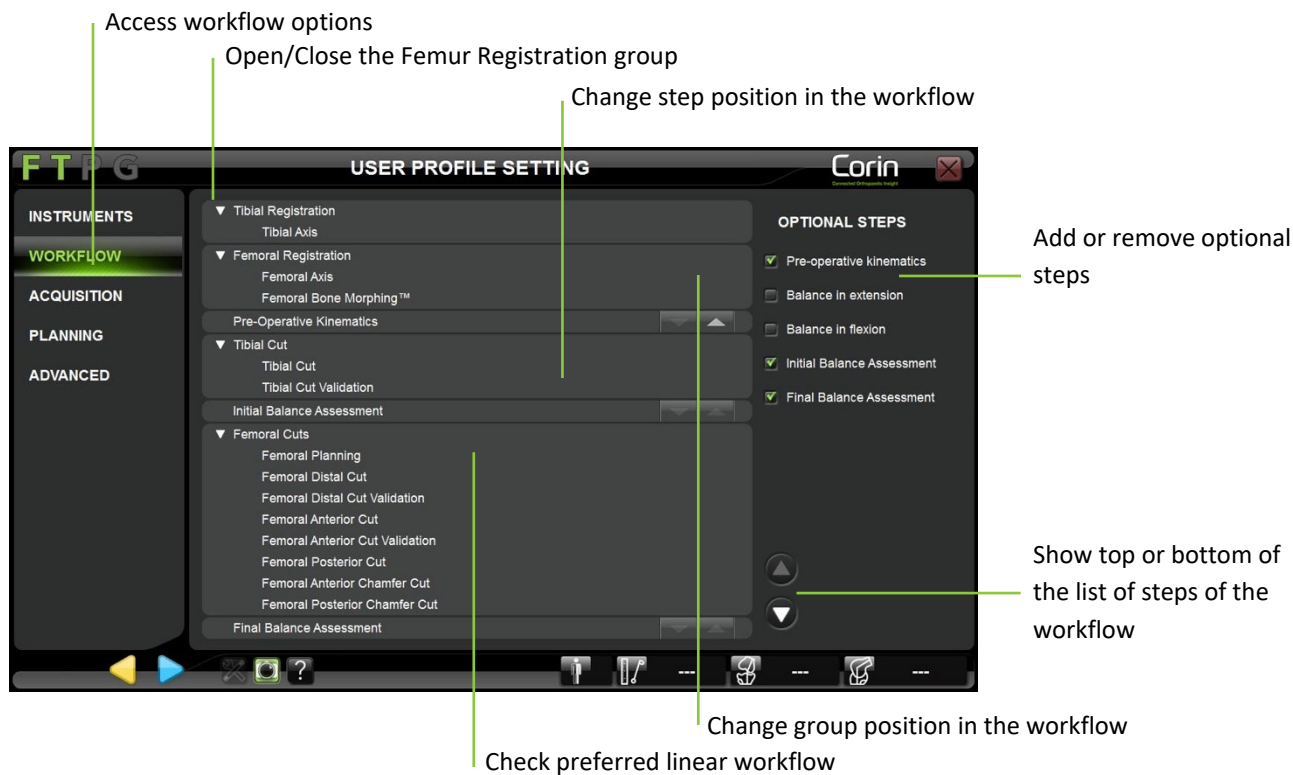

- Tibial cut navigation with Blade Guide (See §4.12)
- Tibial cut navigation with NanoBlock (See §4.14)
- Femoral cuts navigation with NanoBlock (See §4.15 and §4.16)
- Femoral cuts navigation with OMNIBot (See §4.17)
- Initial Balance Assessment and/or Final Balance Assessment with BalanceBot (See §4.12 and 4.19)









Modifying the workflow: Touch “Workflow” tab to view the current workflow (corresponding to the profile selected initially) presented at a group level.



- Add or remove the following optional steps by simply checking or unchecking them in the list:
 - Pre-operative Kinematics (See §4.20);
 - Balance in extension (See §4.10);
 - Balance in flexion (See §4.10);
 - Initial Balance Assessment if BalanceBot is selected (See §4.12);
 - Final Balance Assessment if BalanceBot is selected (See §4.19).

Note: The first few preparation steps (Patient Information, Instruments Calibrations and Reference & Camera positioning) are not represented as they must be performed before any protocol regardless of profile selection.

- Move a group up or down in the workflow by touching  or .

Note: Some groups cannot be moved up or down in the workflow. For example, it is not possible to place the Tibial Cut group after Post-operative Axis step. The buttons are disabled (/) wherever this constraint is present.

- Open or close a group to look at the workflow in more details by touching  or .
- Move a step up or down inside or outside its group by touching  or .

Note: If all the groups are expanded and additional steps are added to the workflow it is possible that list of steps will not fit on the screen. In this case, collapse the groups or touch  or  to scroll through the list.

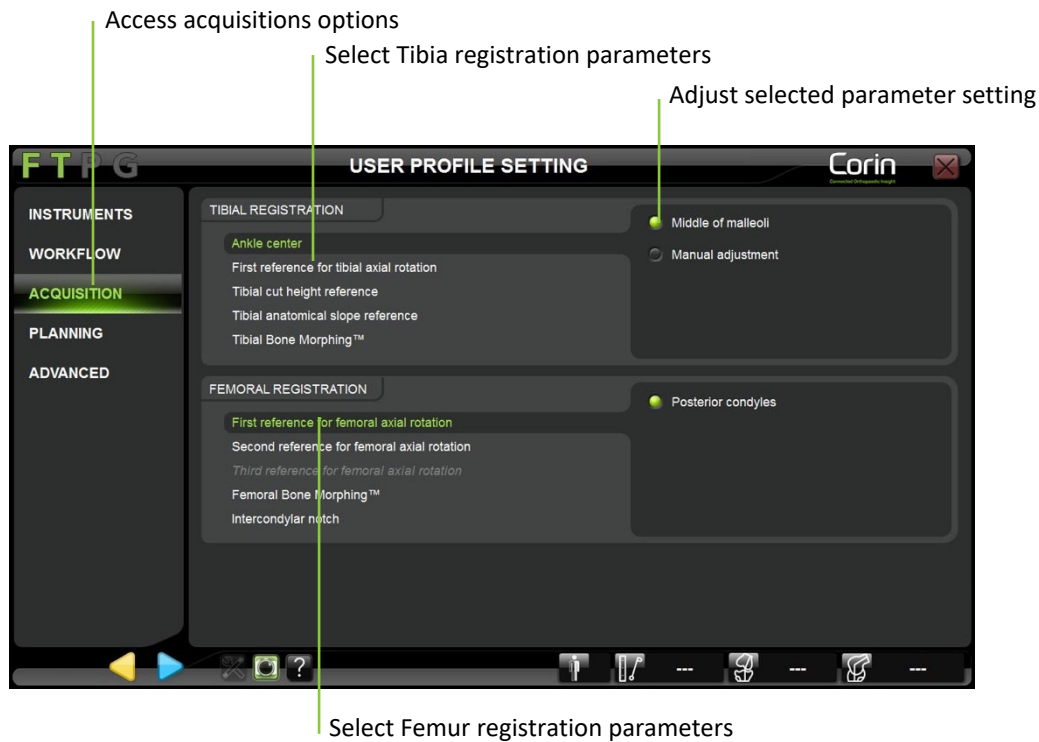

Modifying the acquisitions: Touch the “Acquisition” tab and select the registration parameter to view or modify it.

The Tibial registration parameters are the following:

- Ankle Center: Middle of malleoli or Manual Adjustment
- Tibial axial rotation reference: Axis through intercondylar spine center and ATT;
- Tibial cut height reference: Highest of two digitized plateaus or Lowest of two digitized plateaus;
- Tibial anatomical slope reference: No anatomical slope or Medial or Lateral or Medial & Lateral (Anatomical points acquisition);
- Tibial Bone Morphing: Single point registration or Light Bone Morphing

Note: Tibial registration options cannot be modified once the procedure has started (i.e. these options are not currently available via the Menu). However, the tibial anatomical slope acquisitions remain optional (i.e. they can be bypassed during the protocol by simply hiding both of the required references).

The Femur registration parameters are the following:

- First femoral axial rotation reference: Posterior condyles axis;
- Second femoral axial rotation reference: Epicondyles axis or Whiteside's Line;
- Third femoral axial rotation reference: Epicondyles axis or Whiteside's Line;
- Femoral Bone Morphing: Light Bone Morphing or Full Bone Morphing
- Second reference for femoral distal resection: Top of the Intercondylar Notch;

Note: The Femoral Bone Morphing option cannot be modified once the procedure has started (i.e. these options are not currently available via the Menu).

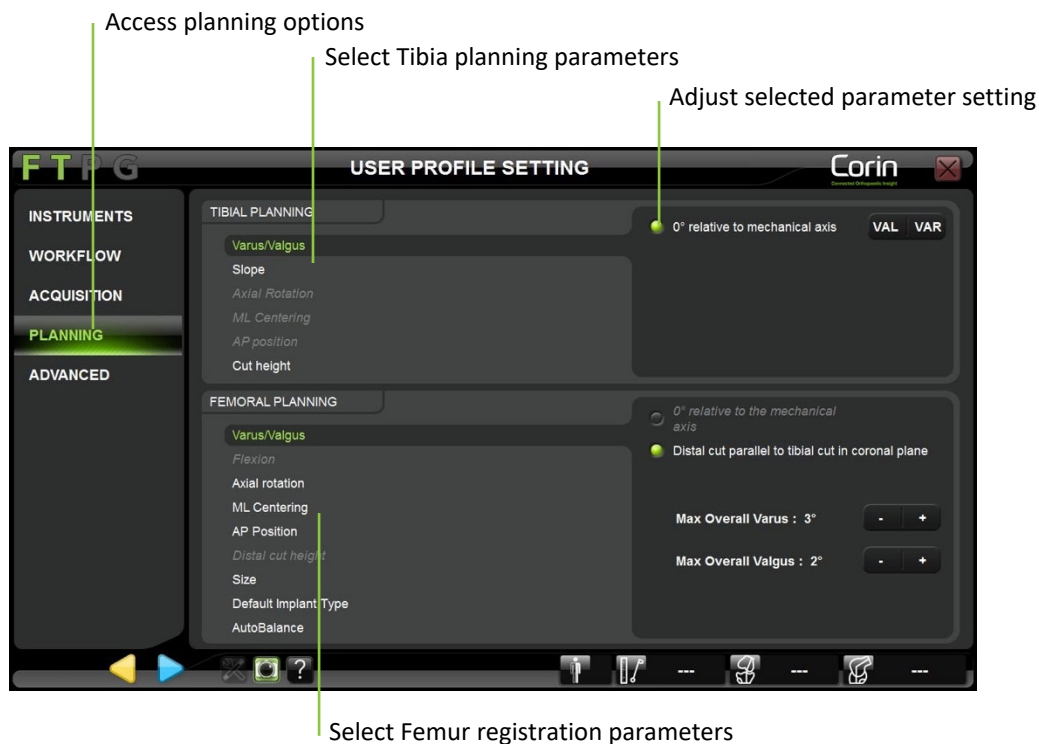

Modifying planning parameters: Touch the “Planning” tab and select the planning parameter to view or modify it.

The Tibial Planning parameters are the following:

- Varus/Valgus: X° relative to the mechanical axis;
- Slope: X° relative to mechanical axis;
- Axial Rotation (if Light Bone Morphing is selected in “Registration” options for Tibia): X° relative to Tibia axial rotation primary reference;
- Medio-Lateral Centering (if Light Bone Morphing is selected in “Registration” options for Tibia): Centering on tibial cut contour;
- Antero-Posterior position (if Light Bone Morphing is selected in “Registration” options for Tibia): Anterior tangency to cut contour;
- Cut Height: X mm relative to Tibial cut height reference;
- Size (if Light Bone Morphing is selected in “Registration” options for Tibia): Corresponding to Femur Size if Femur Size input available / Corresponding to ML dimension of the tibia if Femur Size input not available

The Femoral Planning parameters are the following:

- Varus/Valgus: X° relative to the mechanical axis or Distal cut parallel to Tibial cut in extension if the Balance in Extension step is selected or if the Initial Balance Assessment step is selected in “Workflow” options;
- Flexion: X° relative to mechanical axis;
- Axial Rotation: X° relative to the posterior condyles Axis or Posterior cut parallel to Tibial cut in flexion if the Balance in Flexion step is selected or if the Initial Balance Assessment step is selected in “Workflow” options.
- Medio-Lateral Centering: Centering on femoral contours;
- Antero-Posterior position: Anterior reference or Posterior reference;
- Distal Cut Height: X mm relative to Femur cut height primary reference;
- Size: Largest size without posterior overhanging if Anterior Referencing / Smallest size without anterior notching if Posterior Referencing;
- Implant Type: CR or PS
- AutoBalance: OFF or ON if the Initial Balance Assessment step is selected in “Workflow” options.

Note: The AutoBalance option is available for Apex Knee and Unity Knee and will propose an initial adjustment of the following Femoral Planning parameters:

- Varus/Valgus: Distal cut parallel to Tibial cut in extension (0°) within the limits of 2° Valgus to 3° Varus overall leg alignment.
- Axial Rotation: Posterior cut parallel to Tibial cut in flexion (90°) within the limits of 2° Internal to 8° External Rotation of the femoral component.
- Antero-Posterior position: Anterior reference

In addition, AutoBalance will check the difference between the extension and flexion spaces and will adjust the following parameters to target equal spaces. The range of these adjustments is specific to each implant:

- Flexion;
- Antero-Posterior position;
- Distal Cut Height.

The implant position proposed by the AutoBalance option will not exceed recommended limits that are specific to each implant but the surgeon must use their surgical judgment to control and adjust femoral planning parameters.

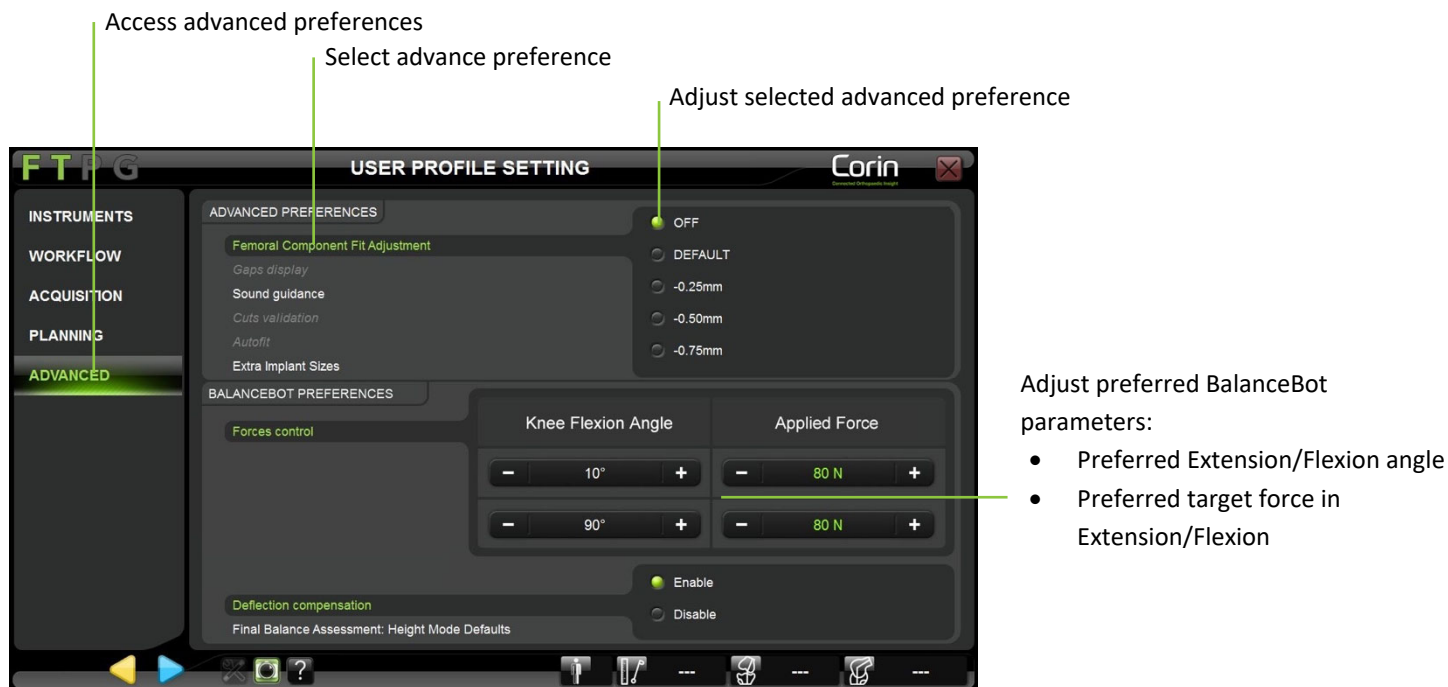

Femoral Component Fit Adjustment: Touch the “Advanced” tab and select Femur Component Fit Adjustment option. Then select preferred default fit setting “Default” (no extra fit) or “-0.25mm” or “-0.50mm” or “-0.75mm” (For more details see §4.11).

Gap display settings (if Balance in extension or flexion is selected): Touch “Advanced” tab and select Gap Display option. Then select the preferred gap display setting: “Implant gap” or “Resection gap” or both (For more details see §4.10).

Note: The Gap display setting is not available with Measured Resection or default Ligament Balancing profiles.

Sound Guidance: Touch “Advanced” tab and select Sound Guidance option. Then select the preferred sound guidance setting: “Before acquisitions” or “During acquisitions” or both.

- If “Before acquisitions” is selected: a “hum” will be audible before each acquisition (calibrations and registrations) as soon as all necessary references (F, T, P or G) are visible and as long as the acquisition is not started.

- If “During acquisitions” is selected: a “tac-tac” will be audible during each continuous acquisition (hip center, surfaces or OMNIBot calibration) as soon as the acquisition is started and all necessary references (F, T, P, or G) are visible and as long as acquisition is not yet completed.

Note: the system will always provide the following sound guidance in addition to Sound Guidance options:

- A validation sound will be emitted at the end of each acquisition or calculation to signify that it was successfully completed.
- A warning sound will be emitted each time the system detects an error. In most of the cases this will go with a warning message.

Autofit – Apex Knee only: Touch the “Advanced” tab and select Cut Validation option. Then select preferred setting “Enable/Disable”. When AutoFit is enabled for the Apex Knee, initial femoral implant flexion and Anterior-Posterior position will be adjusted to propose a better implant size fit to the bone.

Extra Implant Sizes – Apex Knee only: Touch the “Advanced” tab and select Extra Femur Sizes option. Then select preferred setting “Enable/Disable”. When Extra Femur Sizes is enabled for Apex Knee, Femoral planning will propose recently added femur sizes 5+ and 6+ in addition to commonly available sizes 1, 2, 2+, 3, 3+, 4, 4+, 5 and 6 as well as the 13mm insert thickness when using the CR femur.

Force Control (if the BalanceBot is selected): Touch the “Advanced Preferences” tab and select Force Control option. Then use +/- buttons to define preferred force control parameters:

- Preferred Extension angle: 0° [0;15°] defines reference knee extension position for Femoral Planning with BalanceBot
- Preferred Flexion angle: 90° [90;100°] defines reference knee flexion position for Femoral Planning with BalanceBot
- Preferred Extension Force: 80N [50;150N] defines default target force in extension for both Initial Balance Assessment and Final Balance Assessment with BalanceBot
- Preferred Flexion Force: 80N [50;150N] defines default target force in extension for both Initial Balance Assessment and Final Balance Assessment with BalanceBot



RECOMMENDATION: When using the BalanceBot for Initial Balance Assessment and/or Final Balance Assessment it is recommended to limit the maximum force target in both extension and flexion to 120N

Deflection compensation: Touch the “Advanced” tab and select Deflection compensation option. Then select preferred setting “Enable/Disable”. When Deflection compensation is disabled, the BalanceBot will stop compensating actively for mechanical deflection as a function of the force measured but will statically overshoot the nominal target position to compensate for the mean deflection.

Final Balance Assessment: Height Mode defaults: Touch the “Advanced” tab and select Final Stability Assessment: Height Mode defaults option. Then select preferred default display for Final Stability Assessment in Height Mode: “Force Table” and/or “Balance Graph”. For more details see §4.19.

Saving a customized user profile:

- Touch  any time after the last modification to the profile selected initially.

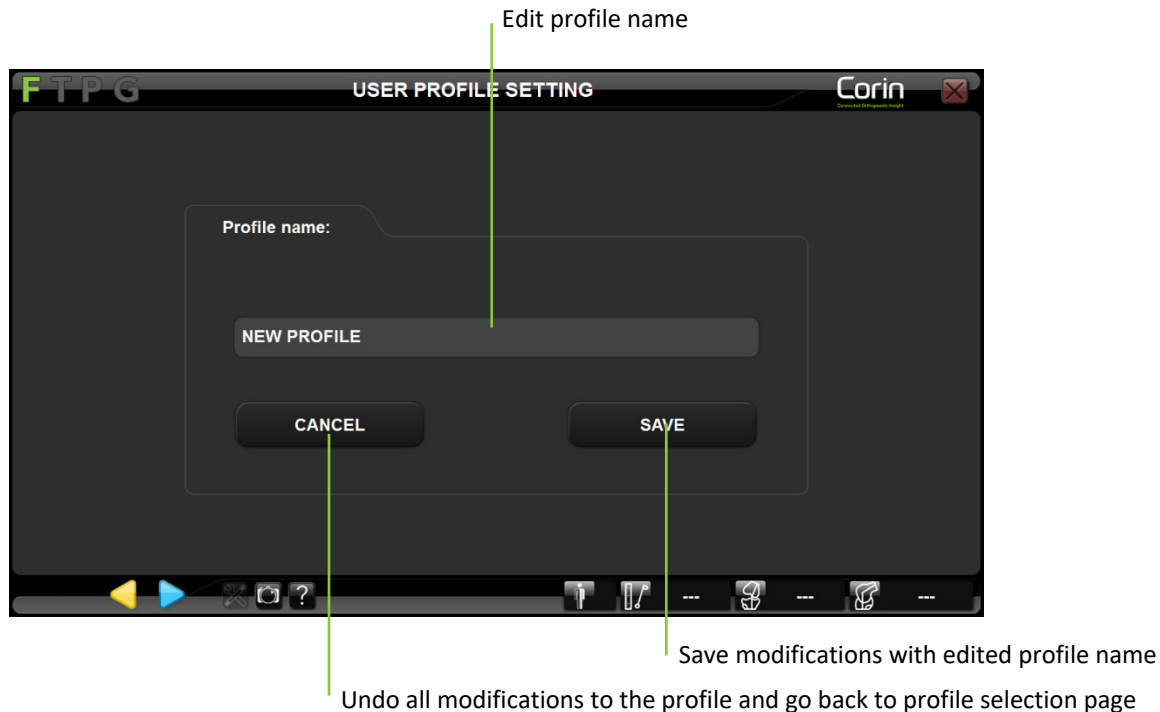

- Give the profile a new name using the keyboard or leave the existing profile name to replace it.
Note: Default profiles are protected (i.e. a customized profile cannot be saved with the same name as a default profile). If a default profile is selected to create a customized profile, a new profile name must be given to save the modifications.
- Touch the “Save” button to save the modified profile with the given profile name.
Note: Once saved the profile can be selected during future sessions. It is possible to save multiple customized profiles. Each profile must be given a unique profile name.

5.4 Menu

The Menu is a graphical interface giving an access to steps or groups of the linear workflow following rules defined in next section (§5.5).



Open Menu

Navigating within the Menu with touch interface:

- Touch .



Close Menu

Go to selected step

Select the step to go to

Select the tab to open

- The Menu gives access to the following additional tabs or categories:
 - Calibration
 - Tibial Registration
 - Femoral Registration
 - Tibial Cut
 - Femoral Cuts
 - Kinematics
- Touch any tab or category to see the steps it contains.
- Touch any step item or pictogram to see a preview or a screenshot of the corresponding step.
- Double tap any step item or touch  to go to the selected step. See §5.5 for more details about Menu.



WARNING: Using Menu to go to any step in the protocol will modify the workflow.

If the user moves to any step with parent steps, then the system will require the parent steps to be completed before reaching the targeted step.

If the user moves to any step with children, then the system will require the child steps to be completed after the targeted step before going back to linear workflow.

- Touch  to close the menu with no incidence on the workflow.

Calibration tab/category:

This tab gives access to the following items to calibrate or re-calibrate any or all instruments during a procedure:

- Pointer
- Blade Guide (if the option is selected)
- Validation Plate
- NanoBlock (if the option is selected)
- OMNIBot Saw Guide (if the OMNIBot option is selected)
- OMNIBot Base (if the OMNIBot option is selected)
- OMNIBot Connection (if the OMNIBot option is selected)
- BalanceBot Calibration (if the BalanceBot option is selected)
- **Calibrate All**

Tibial Registration tab/category:

This tab gives access to the following steps to check, register or re-register any or all of them during a procedure:

- Ankle Center
- Tibial Center
- Anterior Tibial Tuberosity
- Resection References
- Confidence Point (if the Single Point Registration option is selected)
- Bone Morphing Registration (if the Bone Morphing option is selected)
- Bone Morphing Add Points (if the Bone Morphing option is selected)
- Bone Morphing Validation (if the Bone Morphing option is selected)
- **Register All**

Note: The Menu will prevent the access to the Tibial Registration tab until the Pointer has been calibrated.

Femoral Registration tab/category:

This tab gives access to the following steps to check, register or re-register any or all of them during a procedure:

- Hip Center
- Femoral Center
- Posterior Condyles
- Epicondyles
- Whiteside’s Line
- Bone Morphing Registration
- Bone Morphing Add Points
- Bone Morphing Validation
- **Register All**

Note: The Menu will prevent the access to the Femoral Registration tab until the Pointer has been calibrated.

Tibial Cut tab/category:

This tab gives access to the following steps to check, complete or repeat any or all of them during a procedure:

- Planning (if the Bone Morphing option is selected)
- Cut
- Cut Validation
- **Cut/Recut All**

Note: The Menu will prevent the access to the Tibial Cut tab until the full Tibial Registration has been completed.

Femoral Cuts tab/category:

This tab gives access to the following steps to check, complete or repeat any or all of them during a procedure:

- Planning
- Distal Cut Nav. (if the NanoBlock option is selected for femur)
- AP Cuts Nav. (if the NanoBlock option is selected for femur)
- OMNIBot Alignment. (If OMNIBot option is selected)
- OMNIBot Calibration (If OMNIBot option is selected)
- Distal Cut (If OMNIBot option is selected)

- Anterior Cut (If OMNIBot option is selected)
- Posterior Cut (If OMNIBot option is selected)
- Anterior Chamfer Cut (If OMNIBot option is selected)
- Posterior Chamfer Cut (If OMNIBot option is selected)
- Distal Cut Validation
- Anterior Cut Validation
- **Cut/Recut All**

Note: The Menu will prevent the access to the Femoral Cuts tab until the full Femoral Registration has been completed.

Kinematics tab/category:

This tab gives access to the following steps to check, complete or repeat any or all of them during a procedure:

- Pre-operative Kinematics
- Initial Balance Assessment (if the option is selected)
- Final Balance Assessment (if the option is selected)
- Balance in Extension (if the option is selected)
- Balance in Flexion (if the option is selected)
- Post-operative Kinematics

Note: The Menu will prevent the access to the Kinematics tab until the full Tibial and Femoral Registration has been completed.

Refer to User Preferences §5.3 for options selection.

5.5 Using Menu

Note: In the following figures, a blue arrow represent use of ▶ to go forward in the workflow, a yellow arrow represents use of ◀ to go backward in the workflow, a green arrow represents use of the Menu to go directly to a chosen step

Returning to a previous step in the linear workflow:

- Touch ◀ multiple times until the desired step is reached.
- Touch ▶ to redo a step and return to the current step in the linear workflow.

FIG.1

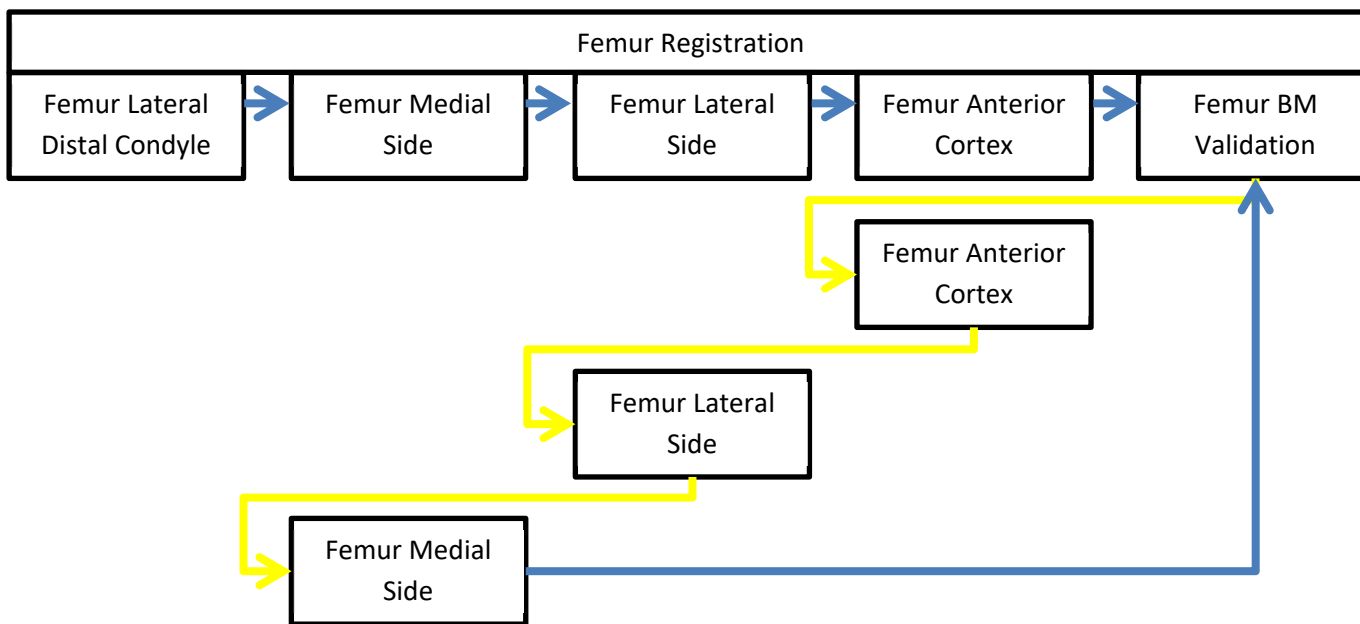

Note: Going back in the workflow using ◀ is limited to groups. However, it is possible to return to a previous group if first step of the new group is not yet validated.

In the example below, it is possible to return to the Tibia Registration group as long as Pre-Operative Kinematics has not been validated (Fig. 2.1).

FIG.2.1

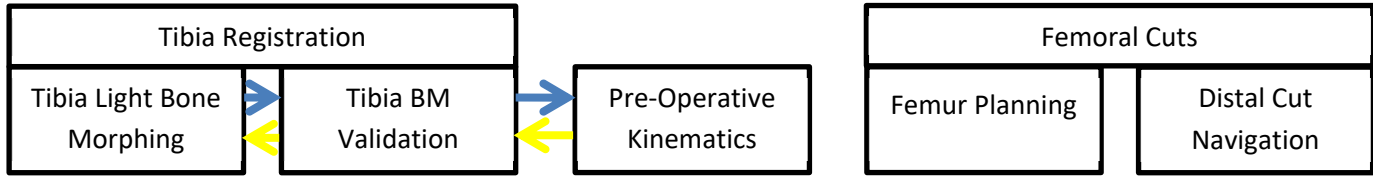
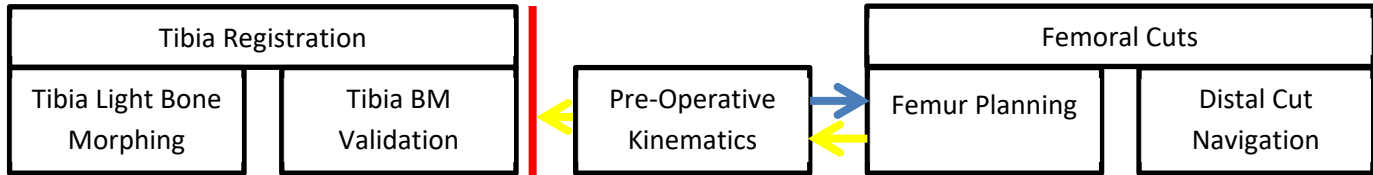

FIG.2.2



Advancing to a step:

- Select the step you want to advance to in the Menu and touch “Go”.

Note: Advancing to a step with Menu will include both the parent steps (usually generating inputs necessary to the specified step) and children steps (usually control steps) if necessary.

In the example below, the user wants to cut the tibia before performing Femur Bone Morphing:

- Jumping to Tibial Cut Navigation with Menu requires a validated Tibia Planning.
- After Tibial Cut Navigation: Tibial Cut Validation will be performed immediately.

FIG.3

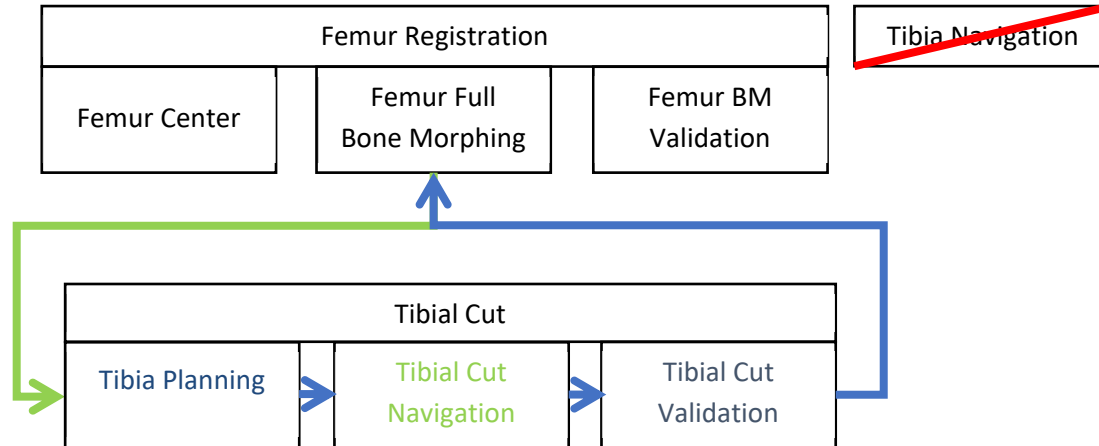

Redoing a step before cuts:

- Select the step to redo in the Menu and touch “Go”.

Note: Redoing a step with Menu will include some children steps (usually control steps), if necessary, before coming back to linear workflow.

In the first example below (Fig. 4.1), the user reacquires the Posterior Condyles during Femur Planning. It will require a new Bone Morphing validation before returning to Femur Planning as Posterior Condyles are the femur primary rotation reference and so an input to the Bone Morphing. In the second example (Fig. 4.2), Whiteside line is a secondary rotation reference that will not affect the Bone Morphing.

FIG.4.1

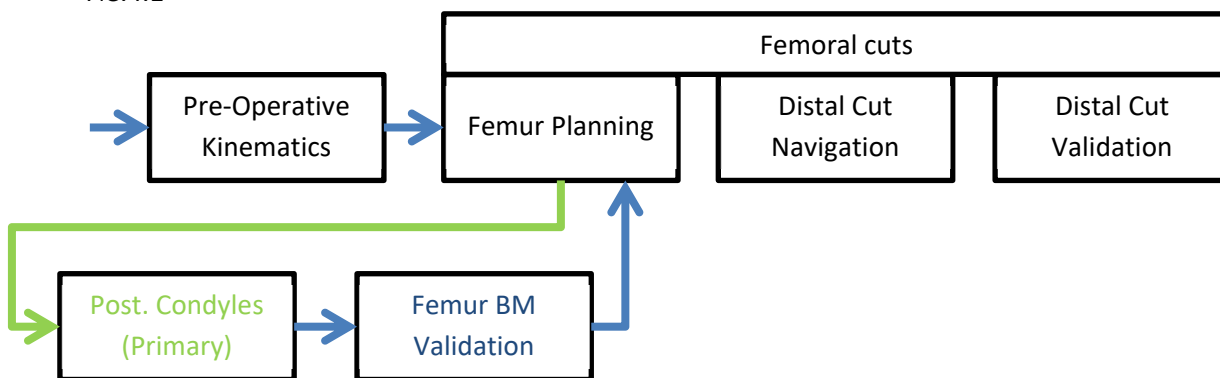
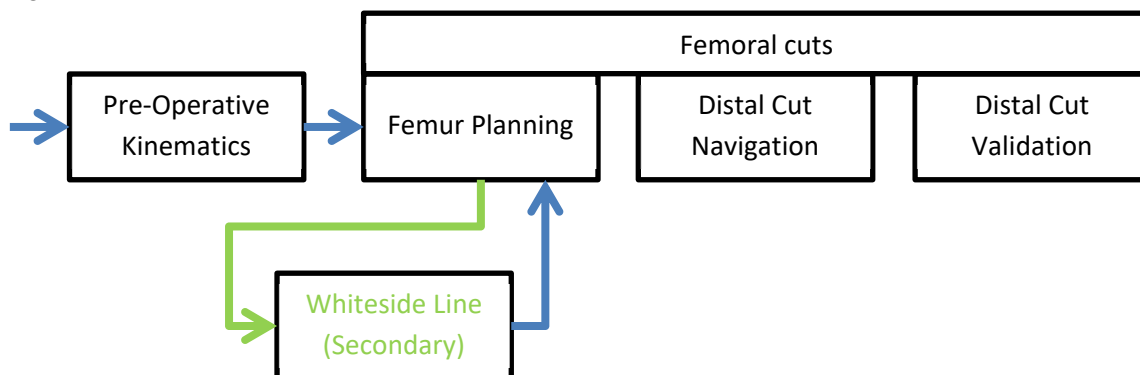

FIG.4.2



Redoing a step during cuts:

- Select the step to redo in the Menu and touch “Go”.

Note: Redoing a step with Menu will, if necessary, include some children steps (usually control steps) before returning to the linear workflow.

In the 1st example below, the user goes to Femur Planning during Anterior Cut Navigation.

FIG.5.1

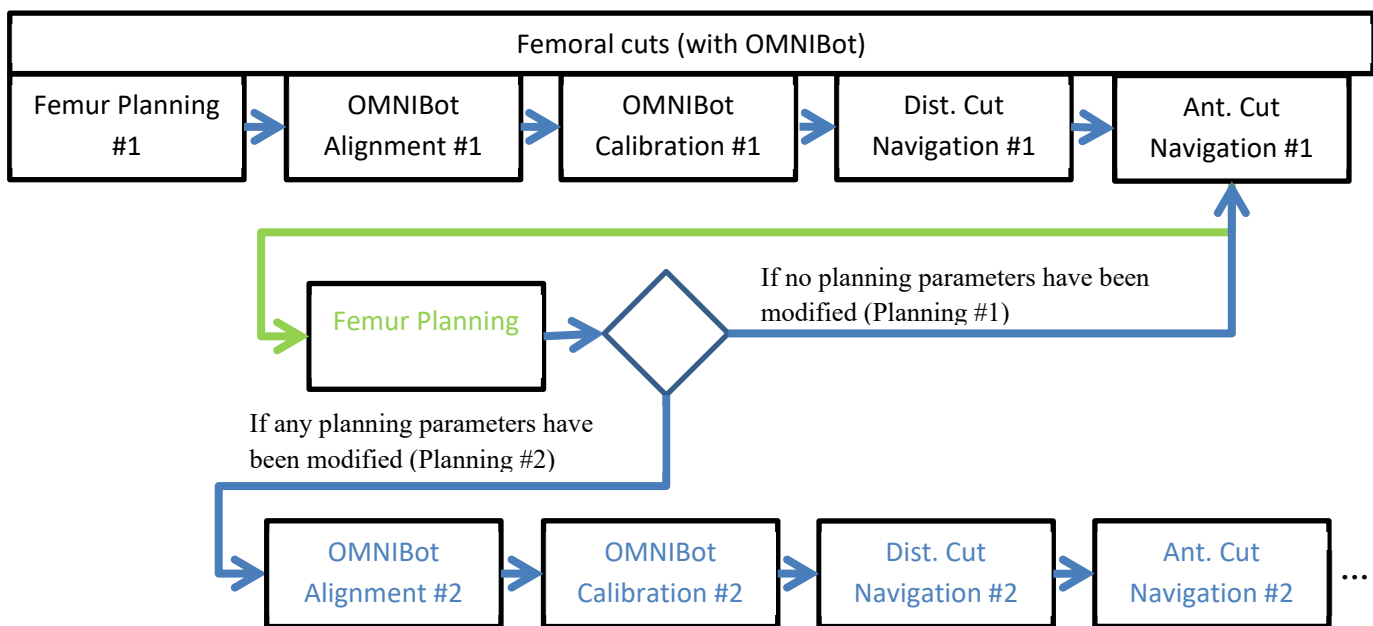

In the 2nd example below, the user wants to redo the Posterior Condyles acquisition (Femur Axial Rotation primary reference) during Anterior Cut Navigation. It will require the new Bone Morphing data to be validated and the Femur Planning to be redone before recalibrating OMNIBot™ and redoing all five femoral cuts.

FIG.5.2

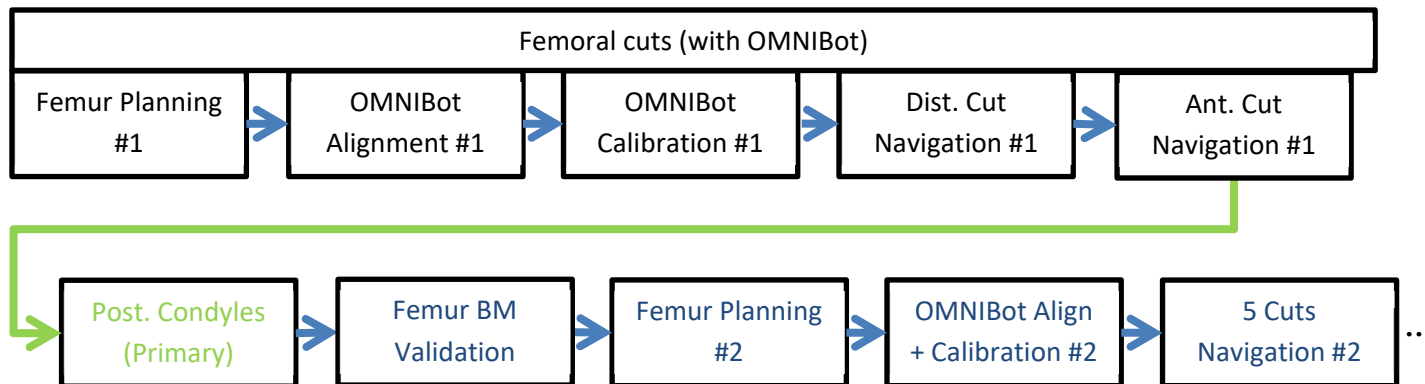

 **WARNING:** Redoing registration step or modifying planning where femoral cuts have partially or completely been performed can cause mismatch between final cuts and implant (i.e. poor implant fit).

Recut the distal femur with the OMNIBot:

- Select the Distal Cut in the Menu and touch “Go”.
- Touch distal resection button to be adjusted then touch + to reset more distal femur.
- Touch and hold  to move the OMNIBot to the new distal cut position.

If some other femoral cuts have already been performed before the distal recut, they should be performed again on order to maintain the perfect consistency of the five femoral cuts with the new position of the femoral component. In this case, the Menu will open automatically following distal recut and it will highlight in red cuts that should be performed again. User can close the menu and ignore this information but Menu button will remain highlighted in red as long as these cuts are not performed again.



Menu opened automatically following distal recut



Menu button remaining highlighted in red

Redoing a step after cuts:

- Select the step to redo in the Menu and touch “Go”.

Note: In this case redoing acquisition step with Menu will not require all child steps to be re-validated as cuts have already been performed. Still, modifying the planning will require cut navigation to be redone and going back to any cut navigation will require new cut validation if the Cut Validation option is selected in User Preferences.

Canceling a jump:

From a step accessed with Menu, it is possible to return to the linear workflow touching  before doing anything else.

FIG.6.1



WARNING: It is no longer possible to return to the linear workflow using yellow button/switch if the first step after a Menu jump has been completed. In this case, the user must complete successive steps (rest of the group or children) to return to the linear workflow.

From a step accessed with Menu, it is also possible to move immediately to a new step with Menu with no impact on the workflow.

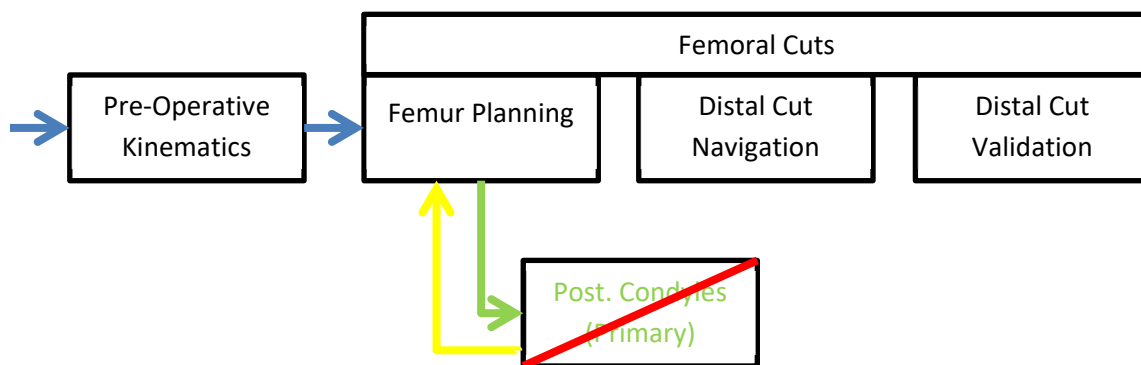
FIG.6.2

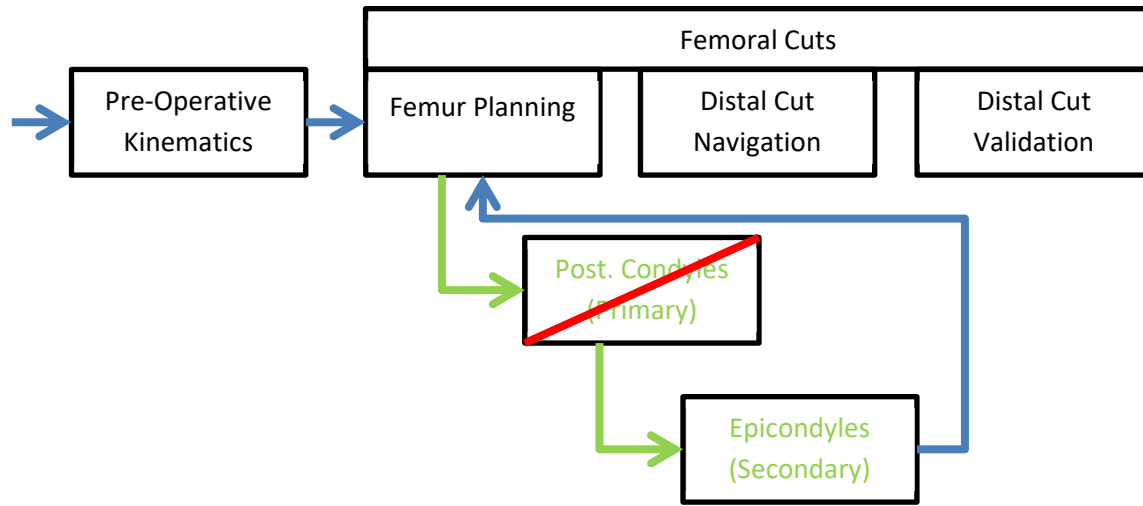

WARNING: It is no longer possible to return to the linear workflow using Menu if the first step after Menu jump has been completed. In this case, the user must complete successive steps (rest of the group or children) before returning to the linear workflow.

From a step accessed by mistake using , it is also possible to move immediately to a new step including the last active step with Menu with no impact on the workflow.

FIG.6.3



Multiple jumps:

It is not necessary to wait until returning to the linear workflow before moving to a different step with Menu.

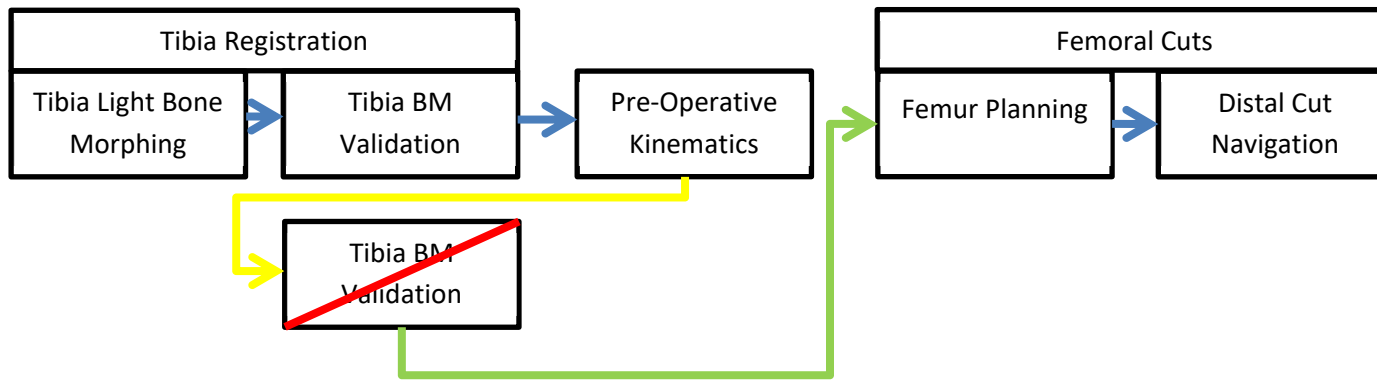
In the example below, the user wants to redo the Posterior Condyles acquisition (Femur Axial Rotation primary reference) during AP Cuts Navigation. It will require the new Bone Morphing data to be validated and a new Femur Plan before returning to the AP Cuts Navigation. When viewing the new plan, the user decides to add a secondary Femur Axial Rotation reference to assess correct rotation of the femoral component.

FIG.7

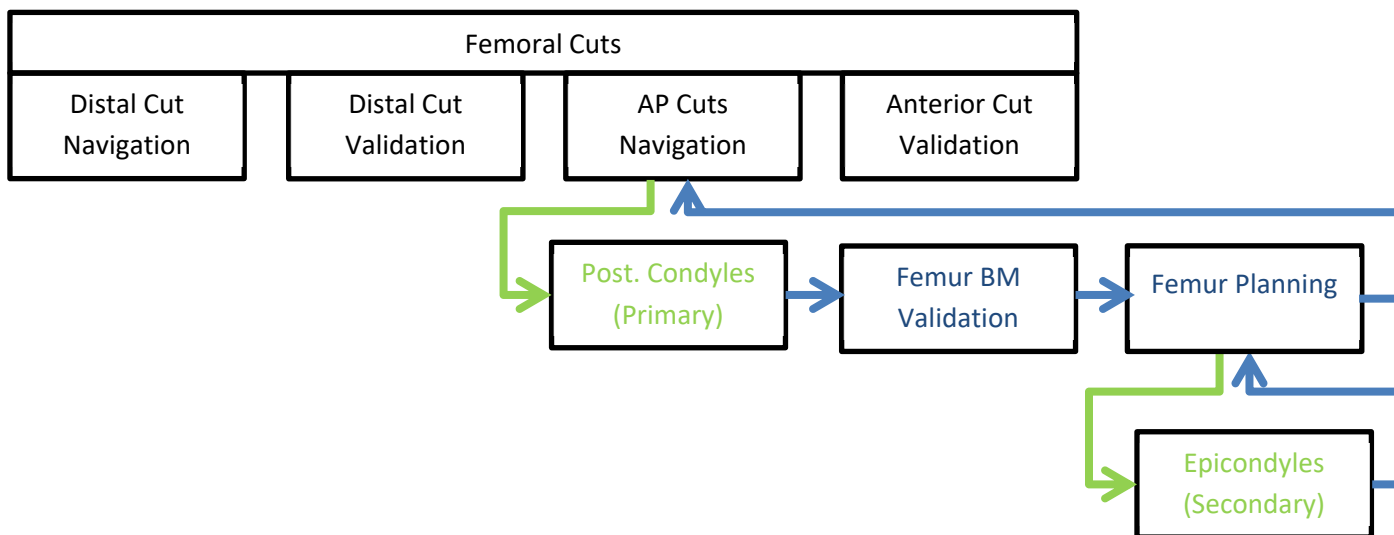

RECOMMENDATION: The user should try to complete all steps following a jump with Menu (i.e. returning to the initial step where the user was before jumping to another step with Menu) as it is not possible stack more than five unclosed Menu loops. In such case, the MENU button will be disabled until the last of the five loops is closed.

Returning to a previous step in the non-linear workflow:

Going back in a group of step initiated by a jump with Menu is possible.

In the example below, the user decides to redo the Femur Light Bone Morphing. During this sequence the user can touch  to go back to any acquisition step in this sequence.

Note: Once 1st step of the sequence is completed it is no longer possible to return to the Femur Planning using . The user should complete all successive steps to reach Femur Planning.

FIG.8



6 Technical notes

6.1 Femur orientation

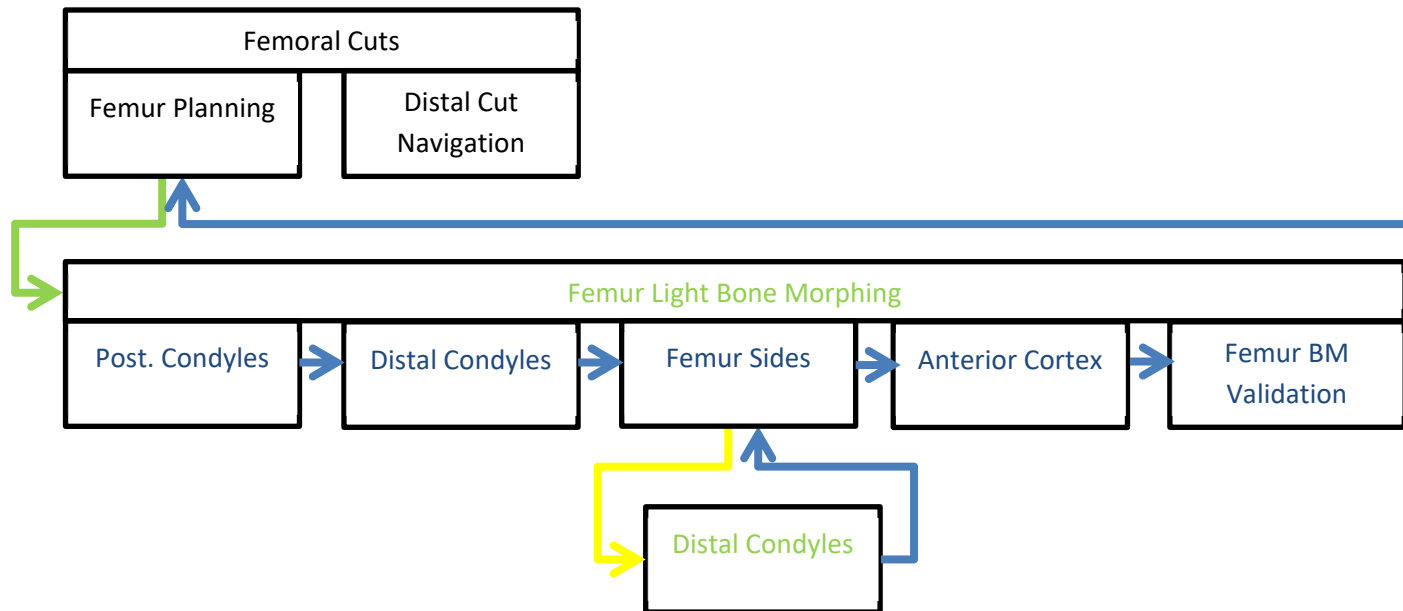
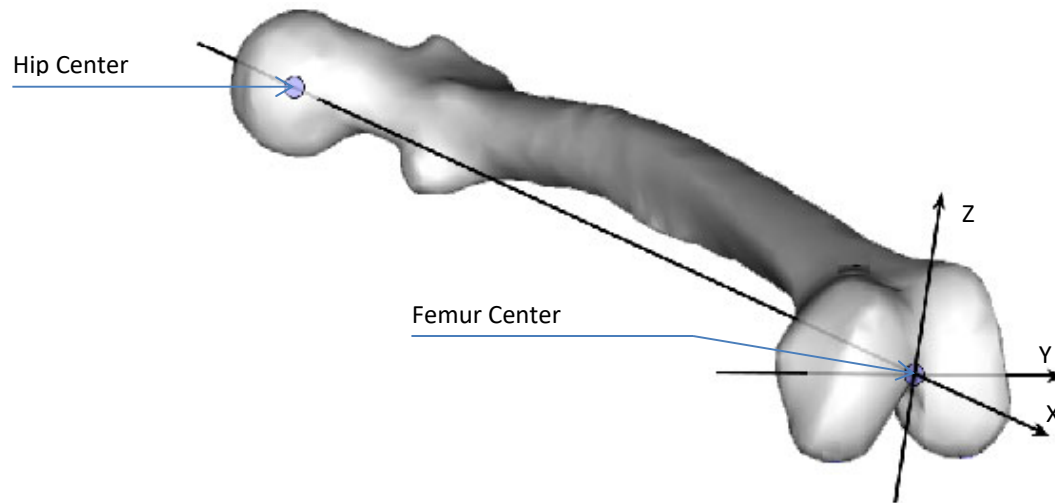

Mechanical axis of the femur:

This axis (Ox) is defined by the line joining the hip center with the femur center.

Axial Rotation Reference of the femur:

This axis (Oy) is defined by the line joining the Posterior condyles as the Primary Reference for the axial rotation. This axis is corrected in the X direction to be orthogonal to the Mechanical axis.

Frontal plane (xOy):

This plane, which defines the frontal view, is the plane passing through the Mechanical axis and the Axial Rotation reference axis.

During Femur implant planning and cut navigation, the Varus/Valgus angle is computed in this frontal plane.

Sagittal plane (xOz):

This plane, which defines the sagittal view, is the plane passing through the Mechanical axis and the Oz axis perpendicular to the Axial Rotation reference axis.

During Femur implant planning and cut navigation, the Flexion angle and the Antero-Posterior offset are computed in this sagittal plane.

Axial plane (yOz):

This plane, which defines the axial view, is perpendicular to the frontal and sagittal planes and passes through the femur center.

During Femur implant planning and cuts navigation, the Axial Rotation angle and the Medio-lateral centering are computed in this axial plane.

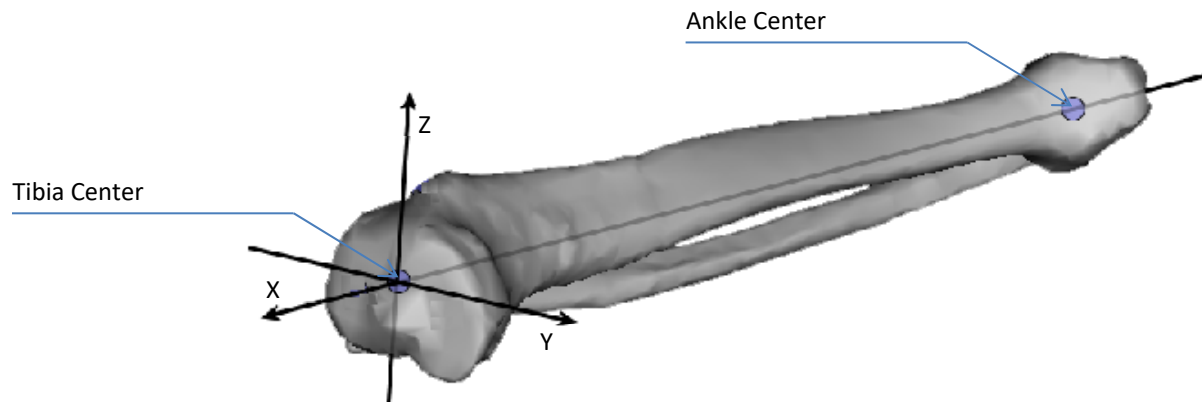
6.2 Tibia orientation**Mechanical axis of the tibia:**

This axis (Ox) is defined by the line joining the ankle center with the tibia center.

Axial Rotation reference of the tibia:

This axis (Oy) is defined by the line joining the tibia center with the anterior tibial tubercle. This axis is corrected in the X direction to be orthogonal to the Mechanical axis.

Front plane (xOy):

This plane, which defines the frontal view, is the plane passing through the Mechanical axis and the Axial Rotation reference axis. During Tibia implant planning and cuts navigation, the Varus/Valgus angle is computed in this frontal plane.

Sagittal plane (xOz):

This plane, which defines the sagittal view, is the plane passing through the Mechanical axis and the Oz axis perpendicular to the Axial Rotation reference axis.

During Tibia implant planning and cuts navigation, the Slope and the Antero-Posterior offset are computed in this sagittal plane.

Axial plane (yOz):

This plane, which defines the axial view, is perpendicular to the frontal and sagittal planes and passes through the intercondylar spines center. During Tibia implant planning, the Axial Rotation angle and the Medio-lateral centering are computed in this axial plane.

6.3 OMNIBotics Bone Morphing™

The aim of OMNIBotics Bone Morphing™ is the intraoperative reconstruction of the patient anatomy 3D model. The system needs to collect data on the anatomical surface to compute this reconstruction.

The reconstruction process starts with an acquisition stage in which points are digitized on the bone surface. The surface points are acquired using the Pointer which needs to slide over the whole surface covering as large an area as possible. It is strongly recommended that all osteophytes are removed before starting the bone surface acquisition process.

Full Bone Morphing acquisition

To aid in the acquisition phase, a generic 3D bone model is displayed on the screen along with the points which are being digitized on the actual patient surface. Once the acquisition is started, the Pointer must not be lifted from the bone surface until the end of the digitization.

In order to achieve the highest accuracy possible, the key point of this acquisition process is the homogeneity of the digitized points. The computation process needs the surface digitization to be as homogenous as possible. To help achieve this, the bone model displayed on the screen is divided in several areas. The system indicates that enough points have been acquired in a given area by changing the color of the area to green. All areas must be covered by point acquisitions before the system starts the reconstruction computation.

It is important that the acquisition is performed very carefully in the areas which will be used for the computation of the implant position. These specific areas are:

- Femur: the distal condyles, the posterior condyles, the medial and lateral borders and the anterior cortical surface.
- Tibia: the medial and lateral borders and anterior tuberosity surface.

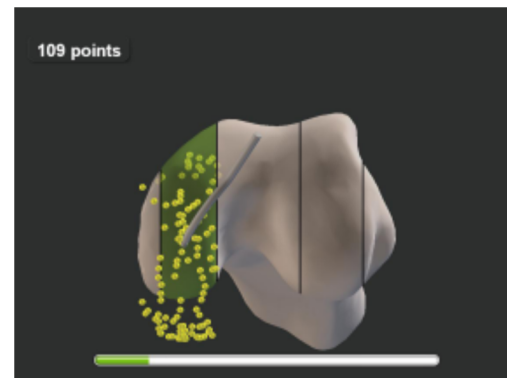
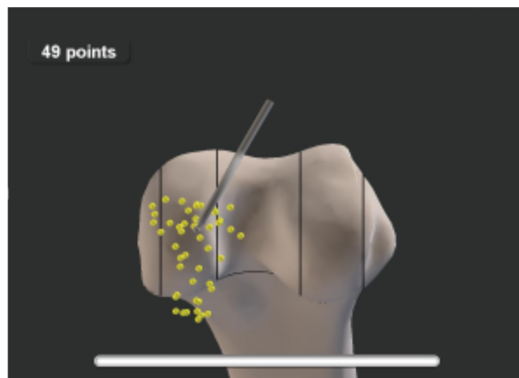

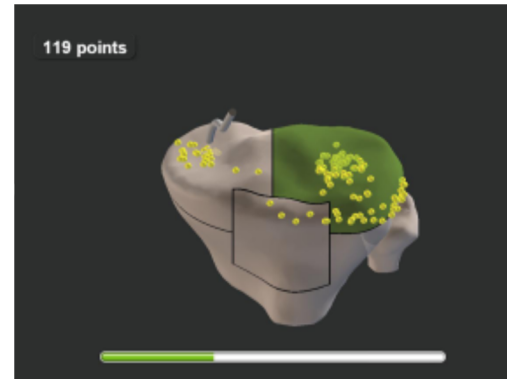
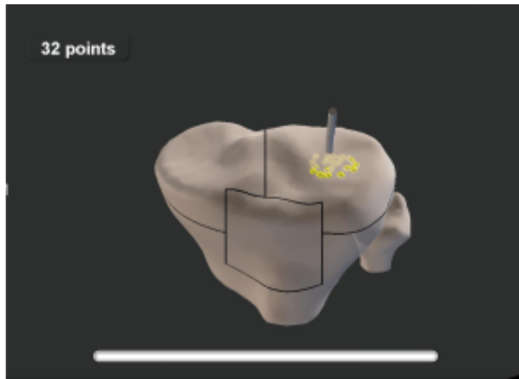

Once all areas have switched to green then the acquisition process completes automatically and the OMNIBotics Bone Morphing™ computation is started.

When the computation is completed, the system checks if the surface coverage has been correctly performed, especially in areas used for the computation of the implant planning position.

The accuracy of the reconstruction is then verified by the user using the pointer (see §4.7). If the surface coverage check is not successful, the system indicates areas where some inaccuracies may have occurred. It is recommended to check the accuracy with the pointer in indicated areas and add some points if necessary in order to achieve the required accuracy.

In the event that some areas do not turn to green, even though as much surface as possible has been covered, it is possible to stop the acquisition manually by pressing the blue pedal. To be able to do this, a minimum number of points on the bone surface must be acquired (500 for the Femur and 200 for the Tibia). If the acquisition is stopped, make sure to check the accuracy after the Bone Morphing computation.

Light Bone Morphing acquisition

In this acquisition mode, the femoral and tibial surfaces are only acquired locally to guarantee accurate positioning of the prosthesis. Once the acquisition is started, the Pointer must not be lifted from the bone surface until the end of the digitization of the current zone. Each zone is digitized separately. To start the acquisition of a zone, place the Pointer on the bone surface and press the blue pedal. Then slide the Pointer over the bone surface covering the entire area of the zone. In order to achieve the highest accuracy possible, the key point of this acquisition process is the homogeneity of the digitized points in the different zones. The computation process prefers that the surface digitization is as homogenous as possible, with a roughly equal spread of points across the zone.

When the acquisition of a zone is completed, the protocol passes to the following zone automatically and you need to press the blue pedal to start the acquisition of this new zone.

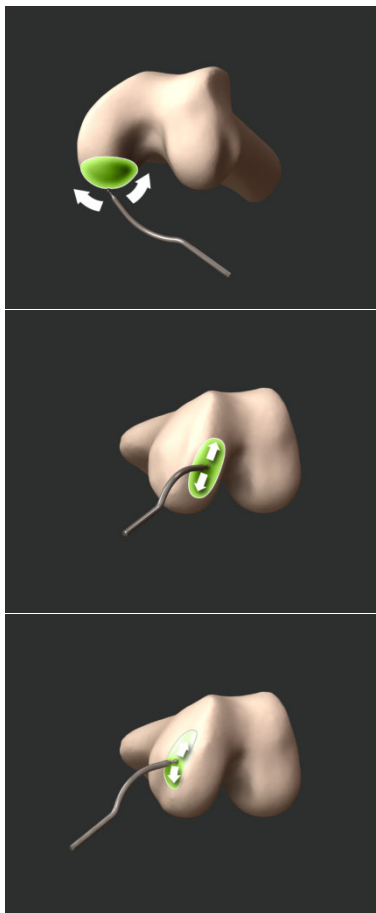

1. Medial Posterior Condyle

3. Medial Distal Condyle

5. Medial Side

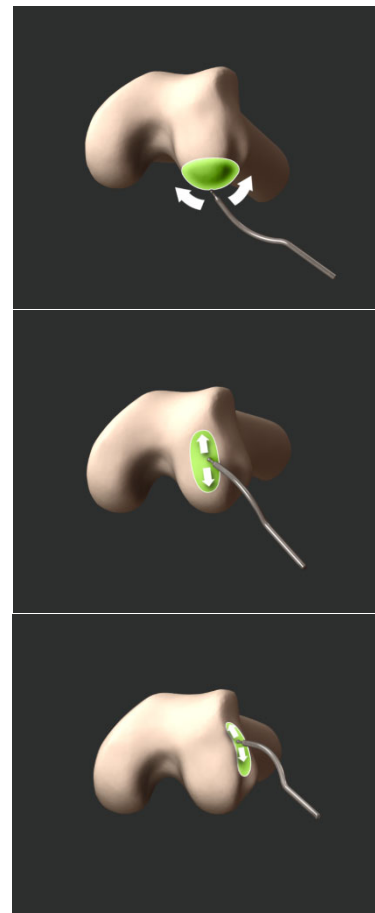

2. Lateral Posterior Condyle

4. Lateral Distal Condyle

6. Lateral Side

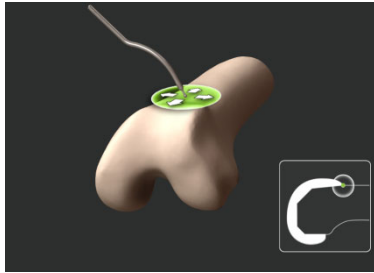

7. Anterior Cortex

When the computation is completed, the system automatically checks if the surface coverage has been correctly performed in areas used for the computation of the implant planning position.

Then you access a stage to check the accuracy of the reconstruction (see §4.7). If the surface coverage check is not successful, the system indicates areas where some inaccuracies may have occurred. It is recommended that the accuracy is checked with the pointer in indicated areas and add some points if necessary in order to achieve the required accuracy.

Bone Morphing Validation

The reconstructed bone model is displayed on the screen and the user is asked to slide the pointer over the patient's actual bone surface again. The distance between the locally reconstructed model and the actual surface can then be checked.

If the accuracy of the reconstruction is satisfactory, i.e. less than 1.0mm in the areas used for implant planning computation, the pointer is displayed in green and you can validate with the blue pedal. If the accuracy is not satisfactory:

- Go back with yellow button to restart some acquisitions from the start
or
- Use Menu to add new points to enrich the acquisitions in the areas where you wish to have more accuracy (recommended).

If additional points are added to increase the accuracy, the points that have already been acquired will not be lost. The acquisition is enhanced with the new acquired points and a new Bone Morphing computation is performed.

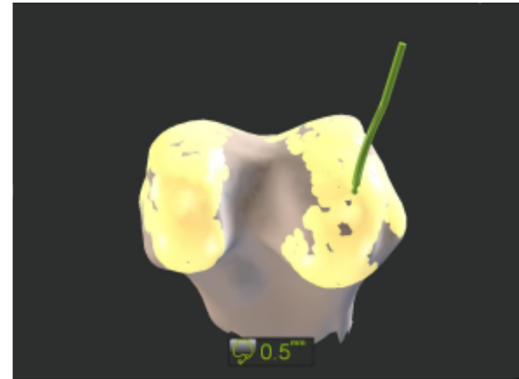

6.4 Leg alignment measurements

Varus/Valgus angle:

It is measured as the angle between Femur Sagittal Plane (See §6.1) and Tibia Mechanical Axis.

In full extension, this angle corresponds exactly to the angle between Femur Mechanical Axis and Tibia Mechanical Axis measured in the Femur Frontal Plane.

This method allows Varus/Valgus measurement at any flexion angle.

Flexion angle:

It is measured as the angle between the Femur Mechanical Axis and the Tibia Mechanical Axis measured in the Femur Sagittal Plane.

Reminder: this measurement can be performed at any time in the navigation protocol as soon as both Tibia and Femur Axis have been fully registered. It only requires having the tibia and femur references visible. The current flexion and varus/valgus angles are computed and displayed in the lower right-hand side of the screen (See §2.9).

Depending on the current stage, the knee center point which is being used to compute this measure is not the same:

- Before planning validations: it is computed from the anatomical Femur and Tibia center points digitized on the patient.
- After planning validations: it is computed from the Femur and Tibia virtual implant center points.
- When using the “Tibia Single Point Registration” option: the anatomical center point acquired on the tibia is used.

6.5 Implant Planning measurements

During the planning step the software automatically proposes a size and a position for the femoral implant based on the user preferred optimization criteria defined in the “Planning” section of profile settings.

The proposal includes the choice for the size of the implant, and a numerical value computed for each of the positioning parameters: 3 rotations (Flexion/Slope, Varus/Valgus, Axial Rotation) and 3 translations (Distal Cut height, Antero-Posterior offset, Medio-Lateral centering).

All these numerical data are computed from the virtual implant position in relation to the reconstructed bone model.

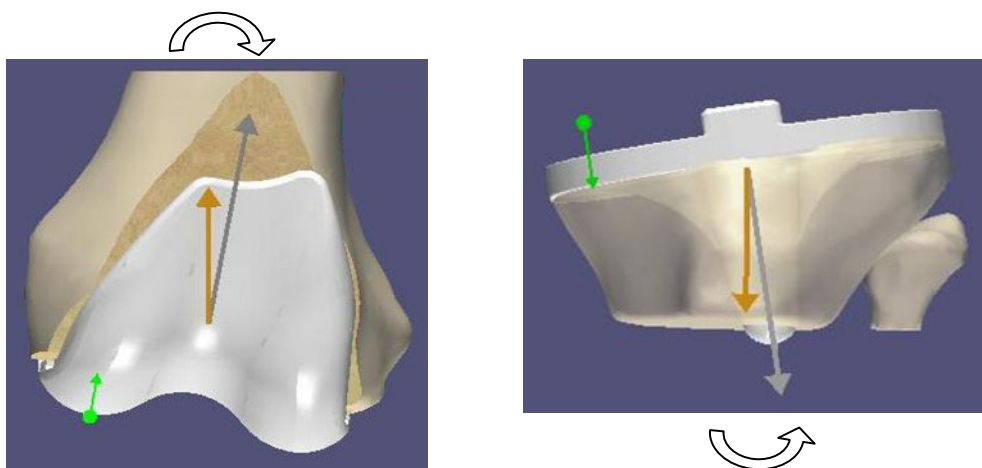

The **Varus/Valgus** angle of the femoral implant (or tibial implant) is computed as the angle between the axis joining the Hip Center (or Ankle Center) and the Implant Center and the mechanical axis of the implant in the femoral (or tibial) frontal plane.

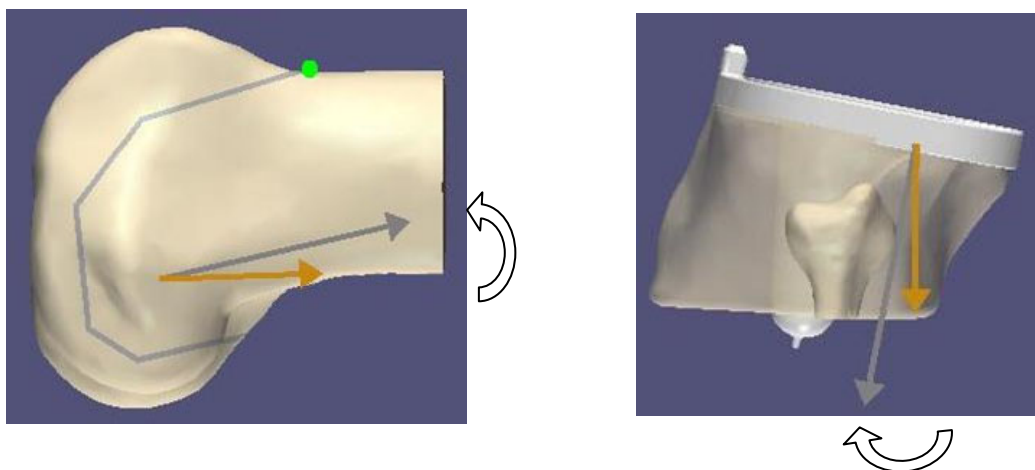

The **Flexion** angle (or **Slope**) of the femoral (or tibial) implant is measured as the angle between the axis joining the Hip Center (or Ankle Center) and the Implant Center and the mechanical axis of the implant in the femoral (or tibial) sagittal plane.

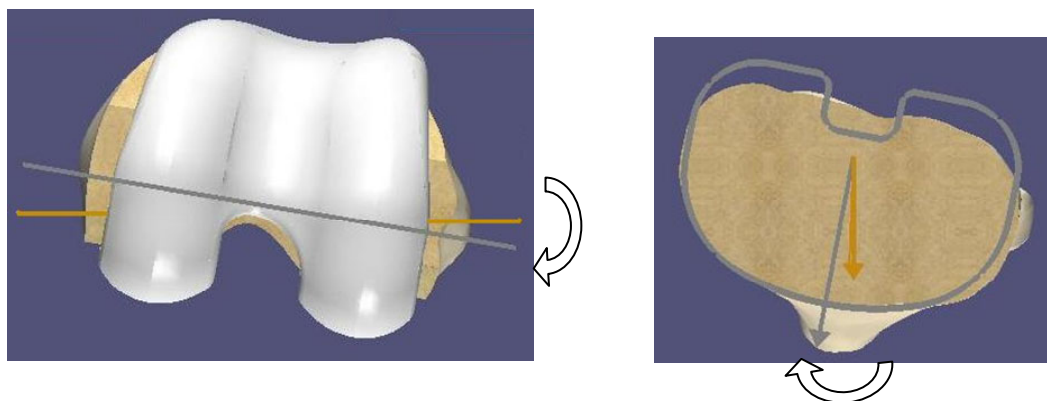

The **Axial Rotation** angle of the femoral (or tibial) implant is computed as the angle between the axis of the primary axial rotation reference of the femur (or tibia) and the axial rotation reference axis of the implant, in the femoral (or tibial) axial plane.

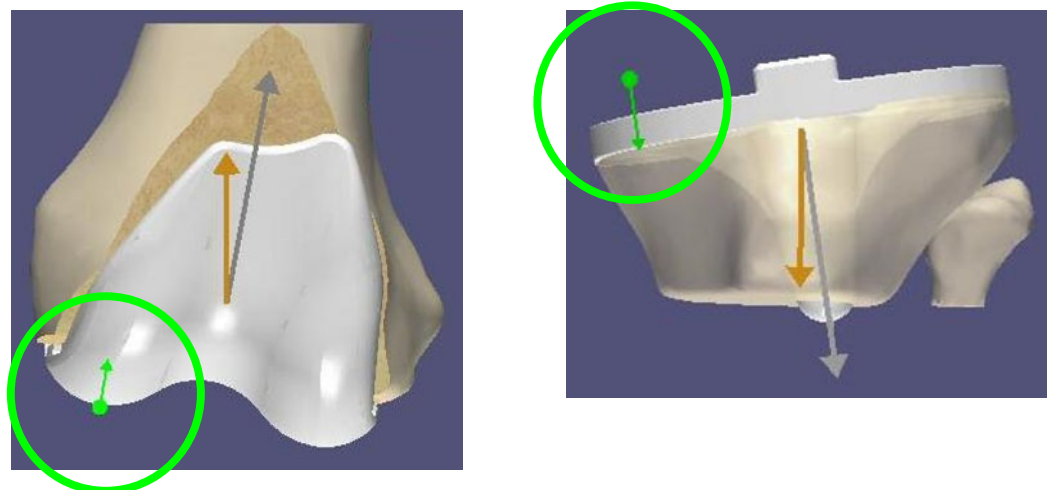

The Distal Cut resection of the femur (or tibia) is computed in the normal direction of the distal cut plane.

6.6 Implant Planning display modes

During both the tibial and femoral planning stages, the graphical display will allow the user to check the information relating to the virtual position of the implant on the reconstructed bone model.

First, the user can verify that the current position has been calculated on the basis of areas with guaranteed accuracy:

- The highly accurate areas where surface points have actually been acquired are displayed as yellow patches on the bone model.
- The contours of the virtual cut are displayed on the bone model in orange.
- If you validate a planning for which there is a risk of inaccuracy in the computing of the implant positioning, the system will display a warning message box to inform you where the inaccuracy may occur. Before validating such a planning, you can use the Pointer to check the accuracy of the bone reconstruction in the areas specified in the message box (See §2.9).

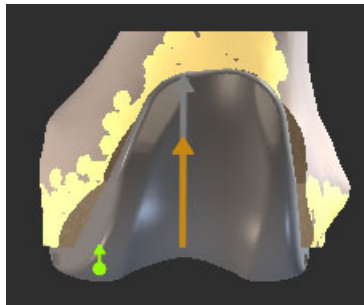

Accurate areas yellow patches



Virtual cut contours

Then, during the femur planning, the user can switch between different modes allowing you to carry out several checks regarding the implant position and cuts:

- Display of the implant over the bone model (default display mode).
- Display of the bone model without the implant showing the virtual cuts that will have to be performed. Within this mode it is also possible to check the fitting of the implant contours on the cut contours. To switch between the two modes, refer to §4.9.

6.7 Navigation steps

Before any navigation step we recommend that you use the Pointer to check that the references have not moved since the anatomical acquisitions. This will ensure that the measurements performed during navigation correspond to the actual measurements (See §2.9).

During a navigation step, the aim is to align the navigated cuts on the planned cuts. As long as this target position is not achieved, the current position of the navigated cut in blue is computed in relation to the planned parameters in white. When all the navigated cut parameters are aligned on the target position, within $\pm 0.5\text{mm}$ and $\pm 0.5^\circ$ of accuracy, the displayed navigated cut line turns green. At this stage, the navigated cutting block must be maintained in position and this position validated pressing blue pedal before proceeding to the cut.

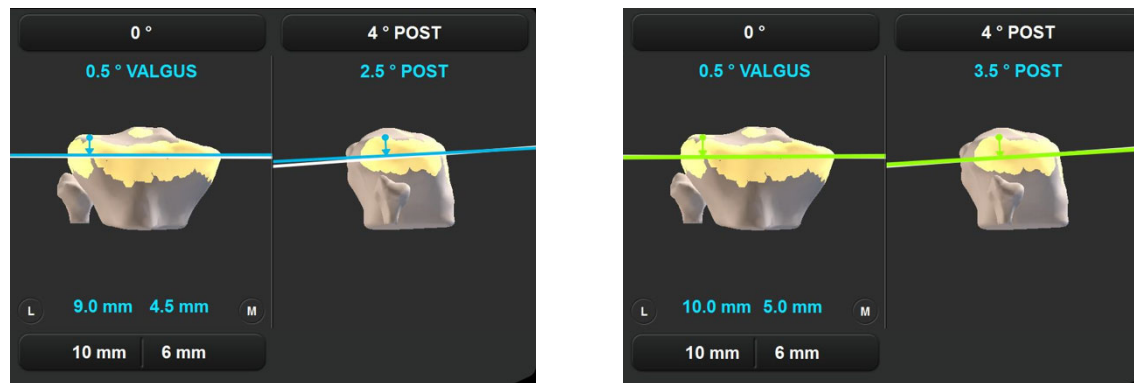

The cut is then performed, and the actual cut is then digitized for control. In this way, the system knows the exact position of the actual cut and these measurements are integrated in the surgical report and in computations performed during the next steps of the protocol.

7 Troubleshooting

PROBLEM	DIAGNOSIS	SOLUTION
One of the references is no longer visible to the system, even if it is in front of the camera.	<ul style="list-style-type: none"> ➤ One of the markers is soiled or out of position. ➤ Disturbance caused by another source of light. 	<ul style="list-style-type: none"> ➤ Check that the markers on the reference are clean and clipped correctly. Change defect markers if necessary. ➤ Change the position and orientation of the camera.
An error message appears at the beginning of the application reporting that the camera is not connected properly.	Problem with the camera connection.	<ul style="list-style-type: none"> ➤ Check the camera connection plug. ➤ Restart the system. ➤ If the problem persists, call maintenance.
An error message appears at the beginning of the application reporting that the camera requires warm-up time.	Camera is out of specified operating temperature range or not yet warmed up.	Wait for a couple of minutes for camera to be warmed up (Power LED I stops flashing) and retry. Next time, start Station a few minutes before starting protocol.
A reference array is not visible and/or the system displays "INFRA-RED DETECTED" in the upper part of the screen	The system detects infra-red interference which blocks the visibility of the references.	<ul style="list-style-type: none"> ➤ Check that no one is in front of camera or directly interfering with camera. ➤ Adjust any surgical lights that may be directly shining on the array or camera. ➤ Modify slightly the position of the camera to reduce interferences.
The anatomic data no longer corresponds to reality (cut planes, position of the tibia in relation to the femur...).	Check that the femur and tibia references are not moving or have not moved.	<ul style="list-style-type: none"> ➤ If a cut has been made and either the femur or tibia references has moved, the surgeon must go back to full registration with Menu if possible or revert to conventional surgical protocol. ➤ If not, it is possible to reattach the references and to full registration with Menu.
Nothing happens when any pedal is pressed.	Problem with the foot pedal connection.	<ul style="list-style-type: none"> ➤ Check the foot pedal connection plug. ➤ If the problem persists, call maintenance. <p>NB: It is possible to perform the procedure using buttons on the touchscreen</p>
Nothing happens when the blue pedal is pressed or the blue arrow is touched.	The references necessary for the stage are not visible.	Make the references visible.

During planning, the system indicates that the prosthesis position cannot be determined.	The system cannot determine the optimal position of the prosthesis with the requested parameters.	Change the parameters for the placement of the prosthesis.
After cut validation, the system indicates that the prosthesis position cannot be determined.	The system cannot determine the optimal position of the prosthesis on the digitized cut.	Make sure the Drill Guide/Cut Controller is correctly placed on the flat surface of the cut and revalidate the cut.
An error message appears once the OMNIBot™ has been connected, indicating a connection problem with the OMNIBot.	Connection problem with OMNIBot.	<ul style="list-style-type: none"> ➤ Check that the green LED light above the OMNIBot connection on the Station's Enclosure Box is illuminated ➤ Check that the cable between the OMNIBot and the Enclosure Box is correctly plugged in. ➤ Check that the OMNIBot USB cable is correctly plugged into the assigned USB port at the back of the laptop dock. If this is not the case, plug it in correctly and restart the knee application software. ➤ If all connections appear correct and the error is still appearing, change the OMNIBot cable if you have a spare. ➤ Repeat all of your connection checks and restart the system. ➤ With all connection checks, be sure to wait at least 10 seconds before trying to connect again. ➤ If you continue to receive the error after all of these checks, contact technical support for assistance.
An error message appears during surgery indicating that the connection to the OMNIBot has been lost.	Connection problem with OMNIBot.	<ul style="list-style-type: none"> ➤ Check that the green LED light above the MOTOR connection on the Enclosure Box is illuminated. ➤ Check that the cable between the OMNIBot and the Enclosure Box is correctly plugged in. ➤ Change the OMNIBot cable. ➤ With all connection checks, be sure to wait at least 10 seconds before trying to connect again.

		<ul style="list-style-type: none"> ➤ If a connection cannot be made, enter SAFETY MODE to manually position the OMNIBot saw guide or switch to conventional instruments.
OMNIBot does not move when the blue pedal is pressed.	The blue pedal was not kept pressed down.	<ul style="list-style-type: none"> ➤ Keep the blue pedal pressed down until the OMNIBot stops moving.
Menu does not jump directly to the selected step.	Selected step requires some parent steps to be performed before (necessary inputs)	<ul style="list-style-type: none"> ➤ Perform required steps until you reach initially selected step.
After performing one or more steps with the Menu, the system does not go back directly to the initial workflow.	Steps performed via Menu require some children steps (which inputs have been modified) to be performed after.	<ul style="list-style-type: none"> ➤ Perform required steps until you get back to initial workflow.
An error message appears once the BalanceBot has been connected, indicating a connection problem.	Connection problem with BalanceBot.	<ul style="list-style-type: none"> ➤ Check that the green LED light above the OMNIBot connection on the Station's Enclosure Box is illuminated ➤ Check that the cable between the BalanceBot and the Station Control Box is correctly plugged in. ➤ Check that the BalanceBot USB cable is correctly plugged into the assigned USB port at the back of the laptop dock. If this is not the case, plug it in correctly and retry connection. ➤ If all connections appear correct and the error is still appearing, change the BalanceBot cable if you have a spare. ➤ Repeat all of your connection checks and restart the system. ➤ With all connection checks, be sure to wait at least 10 seconds before trying to connect again. ➤ If you continue to receive the error after all of these checks, contact technical support for assistance.
An error message appears during surgery indicating that the connection to the BalanceBot has been lost.	Connection problem with BalanceBot.	<ul style="list-style-type: none"> ➤ Check that the green LED light above the OMNIBot connection on the Station's Enclosure Box is illuminated ➤ Check that the cable between the BalanceBot and the Station Control Box is correctly plugged in.

		<ul style="list-style-type: none"> ➤ Change the BalanceBot cable. ➤ With all connection checks, be sure to wait at least 10 seconds before trying to connect again. ➤ If a connection cannot be made, use standard spacer blocks or tibial trial to collect gaps at 0° and 90° flexion to pass ligament balancing step if needed. Final Stability Assessment step will not be available anymore if BalanceBot connection has been lost.
BalanceBot does not move when the blue pedal is pressed at calibration step	The blue pedal was not kept pressed down.	➤ Keep the blue pedal pressed down until the BalanceBot stops moving.
Application workflow reaches the final step of the protocol without requiring completing some Tibia registration or navigation steps. Leg alignment information displayed during Post-Operative Kinematics Step is specious	Menu has been used to bypass missing Tibia registration or navigation steps and then Menu has been used to switch from OMNIBot to NanoBlock instrument option to complete femoral cuts navigation.	➤ Use Menu to access and complete registration or navigation steps that have been bypassed. The missing steps should appear as “unchecked” in the Menu list.
At the beginning of a case, the system doesn't produce any sound when registering landmarks or when validating a step	<ul style="list-style-type: none"> ➤ The sound has been turned OFF on the station monitor. ➤ The laptop didn't recognize the speaker of the monitor (The laptop has been started before the monitor). 	<ul style="list-style-type: none"> ➤ Make sure the volume on the station monitor is ON and loud enough. ➤ Power OFF/power ON the station monitor.

8 Maintenance and monitoring

8.1 Maintenance of the OMNIBot:

To ensure safe operation of the OMNIBot specific maintenance is compulsory.

The OMNIBot motor unit must be returned for maintenance after 12 months for servicing by a service technician qualified by OMNI.

The OMNIBot enclosure must be returned for replacement after 100 uses.

It is not required to lubricate the OMNIBot Motor Unit.

8.2 Maintenance of the BalanceBot:

To ensure safe operation of the BalanceBot unit specific maintenance is compulsory.

The device must be returned for maintenance after 12 months or after 100 uses for servicing by a technician qualified by OMNI.

The ART Knee software does not require any specific maintenance.

For more information see the instructions for use of the system components listed in §1.3 « Associated documents ».